



# X-Guard<sup>®</sup> Technical

Technical information





**X-Guard** is a complete machine guard series that complies with the amended Machinery Directive 2006/42/EC on fixed guards that came into force on 29 December 2009. With its wide range of standard components and accessories, X-Guard is guaranteed to cover all your machine guard needs. X-Guard was launched in 2008 and is under constant development to meet the market need for smart solutions that comply with current directives and requirements.

## X-Guard® – Panels



X-Guard has three types of panels; mesh, plastic and sheet metal. All three have a 30x20 mm frame with factory-fixed brackets to facilitate assembly.

### Mesh panels

Our mesh panels come in two sizes of mesh; Premium 50x20 and Classic 50x30 mm. The safety distance determines the size of mesh required. The Classic 50x30 mesh requires a minimum distance of 200 mm while the Premium 50x20 only requires 120 mm.

The Premium 50x20 is 2200 mm in height and comes in six widths.

The Classic 50x30 comes in four heights. The 750 mm panel is only used as an extension panel to the other heights. The panels come in thirteen widths, with the

exception of the 1300 mm panel, which comes in fourteen widths.

The standard panel colour is RAL 9011 but customised colours are available upon request.

### X-Guard Contour

Mesh panel X-Guard Contour has rounded corners, making it not only the perfect solution for confined but also sleek in design. These panels come in three heights and 90° angle.

### Sheet metal and plastic panels

The X-Guard series also has a range of sheet metal and plastic panels. They come in three heights and widths. Sheet metal panels come in standard colour RAL 9011 (black) and are also available with windows. Two heights and widths.

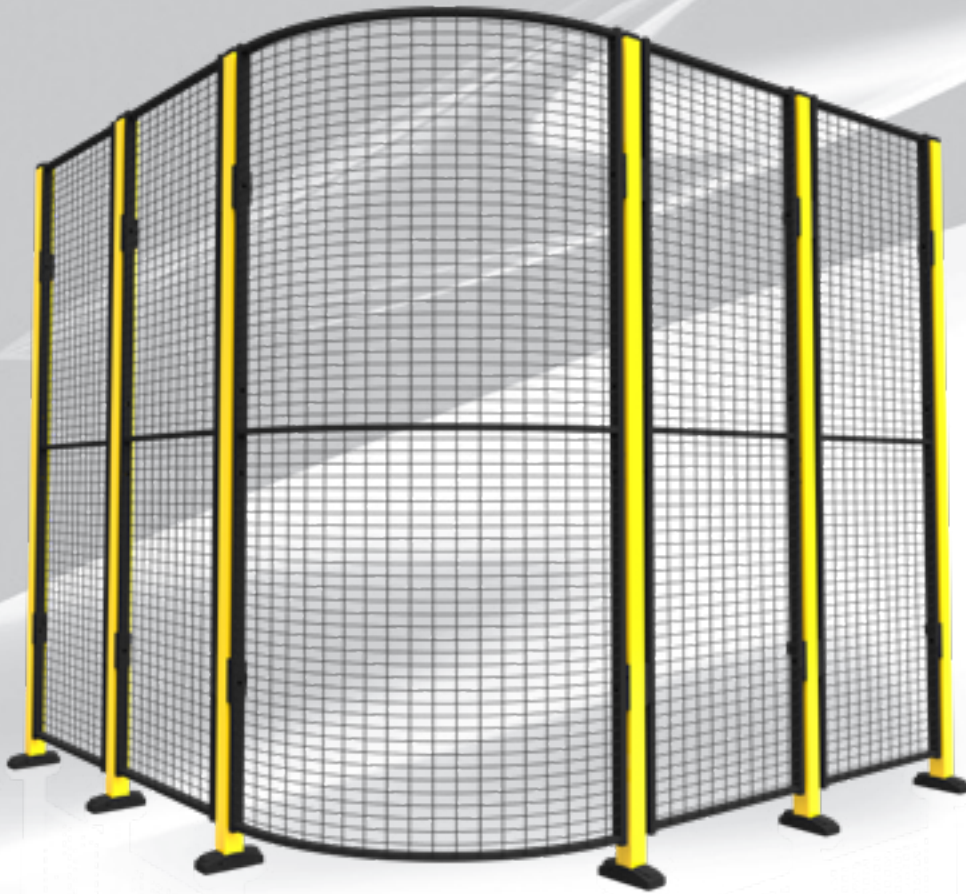

## X-Guard® Contour

In 2012 Axelent launched a unique machine guard, X-Guard Contour, and it has gone on to become a popular choice among our more traditional guards. The rounded panels are part of our X-Guard range and can be combined with other X-Guard components. X-Guard Contour is not only the perfect solution for confined but also sleek in design.

For Art. No. see page 5.

### Product facts X-Guard Contour

Safety distance	200 mm
Uprights	30x20 mm
Horizontals	25x15 mm
Posts	Classic 50x50 mm Premium 70x70 mm
Vertical wires	Ø 3 mm
Horizontal wires	Ø 2.5 mm
Mesh aperture	50x30
Finish	Phosphatising/Epoxy paint
Colour mesh panel	Black RAL 9011
Colour post Classic 50x50 mm	Yellow RAL 1018, Black RAL 9011, Blue RAL 5005, Red RAL 3020
Colour post Premium 70x70 mm	Yellow RAL 1018, Red RAL 3020

(Other colours can be quoted.)

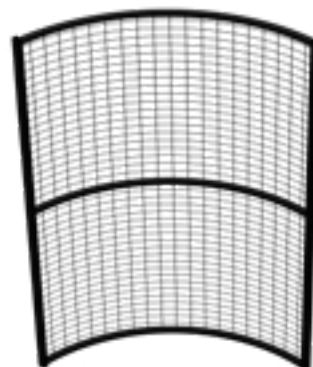
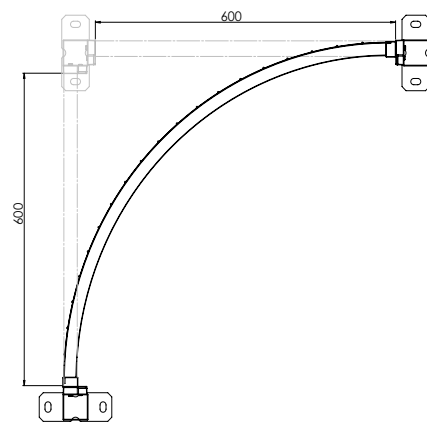

# X-Guard® - Panels

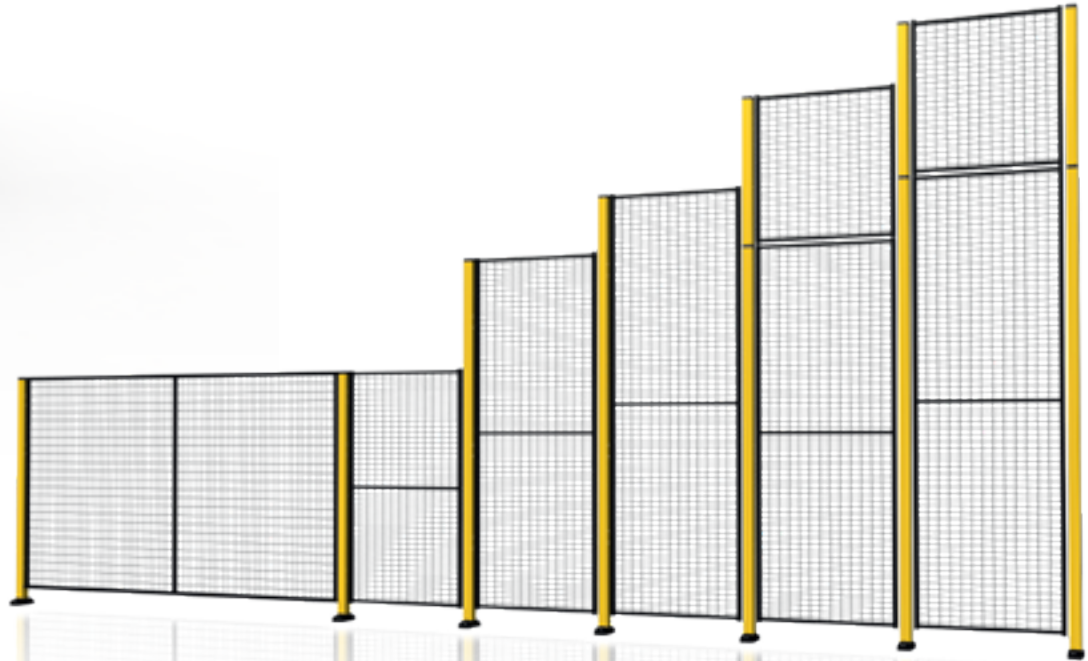

## X-Guard standard colours

Posts Classic 50x50 mm

Yellow  
RAL 1018



Black  
RAL 9011



Blue  
RAL 5005



Red  
RAL 3020

Posts Premium 70x70 mm



Yellow  
RAL 1018



Red  
RAL 3020

Panels



Black RAL 9011

## Mesh

In most environments and for most machines our mesh panels provide ample protection.

Our mesh panels come in two sizes of mesh; Premium 50x20 and Classic 50x30 mm. The safety distance determines the size of mesh required. The Classic 50x30 mesh requires a minimum distance of 200 mm while the Premium 50x20 requires only 120 mm.

Read more about the various coatings on page 42-43.

### Product facts mesh panels

Safety distance	Premium 120 mm Classic 200 mm
Uprights	30x20 mm
Horizontals	25x15 mm
Posts	Classic 50x50 mm Premium 70x70 mm
Vertical wires	Ø 3 mm
Horizontal wires	Ø 2.5 mm
Mesh aperture	50x20, 50x30 mm
Finish	Phosphatising/Epoxy paint
Colour mesh panel	Black RAL 9011
Colour post Classic 50x50 mm	Yellow RAL 1018, black RAL 9011, blue RAL 5005, red RAL 3020
Colour post Premium 70x70 mm	Yellow RAL 1018 Red RAL 3020

*(Other colours can be quoted)*



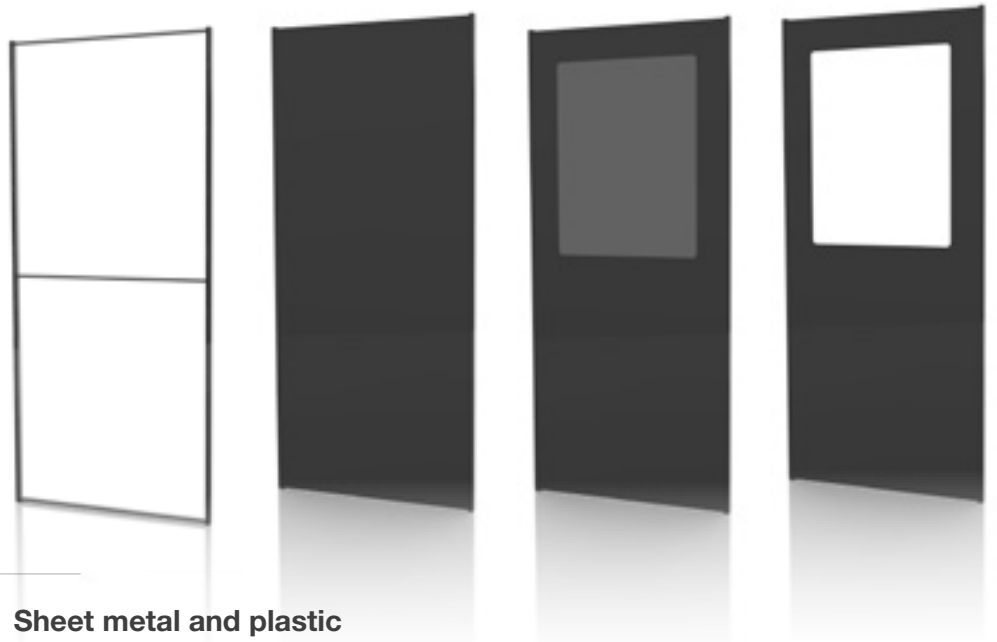

## Sheet metal and plastic

Some environments require more comprehensive protection such as see-through plastic walls or sheet metal covered walls. X-Guard Plastic and Sheet Metal systems are easy to fit and you can use the same posts and door packs as for our other mesh products. To avoid gaps between the section and post we recommend you fit our custom edging plate included with the purchase of sheet metal or plastic panels and posts (see accessories on 28). The plastic walls are heat resistant up to 60 degrees and available in clear plastic. The sections come in four widths and heights.

## Panel with window

When a process needs to be monitored then a windowed panel is the perfect solution. The window is available in clear or coloured plastic, the latter to guard against welding flashes. The coloured plastic meets safety standards EN ISO 25980:2014. Our windowed panel comes in two heights and widths.

## X-Guard standard colours

Posts Classic 50x50 mm

Yellow  
RAL 1018



Black  
RAL 9011



Blue  
RAL 5005



Red  
RAL 3020

Posts Premium 70x70 mm



Yellow  
RAL 1018



Red  
RAL 3020

Panels



Black RAL 9011

## Product facts plastic- and sheetpanels

Uprights	30x20 mm
Horizontals	25x15 mm
Plastic	2 mm (thermoplastic polyester) 3 mm (polycarbonate) "welding green"
Sheet	0,8 mm
Posts	Classic 50x50 mm Premium 70x70 mm
Colour panel	Black RAL 9011
Colour post Classic 50x50	Yellow RAL 1018, black RAL 9011, blue RAL 5005, red RAL 3020
Colour post Premium 70x70	Yellow RAL 1018, red RAL 3020

*(Other colours can be quoted)*

## Plastic

Art.no	Height (mm)	Width (mm)	Art.no	Height (mm)	Width (mm)
<b>Black (RAL 9011)</b>			<b>Black (RAL 9011)</b>		
W328-075025	0750	0250	W328-220025	2200	0250
W328-075040	0750	0400	W328-220040	2200	0400
W328-075070	0750	0700	W328-220070	2200	0700
W328-075100	0750	1000	W328-220100	2200	1000
			<i>(Fixings are included with the panels)</i>		
W328-190025	1900	0250			
W328-190040	1900	0400			
W328-190070	1900	0700			
W328-190100	1900	1000			
<b>Grey (RAL 9018)</b>					
W428-220025	2200	0250			
W428-220040	2200	0400			
W428-220070	2200	0700			
W428-220100	2200	1000			

## Sheet

Art.no	Height (mm)	Width (mm)	Art.no	Height (mm)	Width (mm)
<b>Black (RAL 9011)</b>			<b>Black (RAL 9011)</b>		
W329-075025	0750	0250	W329-220025	2200	0250
W329-075040	0750	0400	W329-220040	2200	0400
W329-075070	0750	0700	W329-220070	2200	0700
W329-075100	0750	1000	W329-220100	2200	1000
			<i>(Fixings are included with the panels)</i>		
W329-190025	1900	0250			
W329-190040	1900	0400			
W329-190070	1900	0700			
W329-190100	1900	1000			
<b>Grey (RAL 9018)</b>					
W429-220025	2200	0250			
W429-220040	2200	0400			
W429-220070	2200	0700			
W429-220100	2200	1000			

## Sheet with window (clear and weldinggreen)

Art.no	Height (mm)	Width (mm)	Art.no	Height (mm)	Width (mm)
<b>Clear · Black (RAL 9011)</b>			<b>Clear · Black (RAL 9011)</b>		
W330-190070	1900	0700	W330-220070	2200	0700
W330-190100	1900	1000	W330-220100	2200	1000
<b>Weldinggreen · Black (RAL 9011)</b>			<b>Weldinggreen · Black (RAL 9011)</b>		
W331-190070	1900	0700	W331-220070	2200	0700
W331-190100	1900	1000	W331-220100	2200	1000
			<i>(Fixings are included with the panels)</i>		



## X-Guard® – Posts

X-Guard is available with two post sizes; Classic 50x50 mm and Premium 70x70 mm.

### **Classic 50x50 post**

The Classic 50x50 mm post comes in 4 heights and has an extension piece of 750 mm. Colours range from RAL 1018 (yellow), RAL 5005 (blue), RAL 9011 (black) and RAL 3020 (red).

This post comes with a foot cover that hides the welded foot. It has a sleek design and makes cleaning so much easier.

### **Premium 70x70 post**

The Premium 70x70 mm post comes in 3 heights and has an extension piece in four different heights. The standard colour is RAL 1018 (yellow) and RAL 3020 (red) with a RAL 9011 black foot.

This post is shipped with a separate foot that can be fitted at four different angles. The foot plate is not centred

so offers the perfect solution in tight spaces. This post is suitable when a more robust and higher machine guard is needed.

Both posts have holes punched on three sides to facilitate fitting, and a floor gap of 100 mm. Customised colours are available upon request.

Top plugs and expansion bolts for floor fixing are included with both posts.

### **Post prepared for push buttons**

Axellent has developed X-Guard posts ready prepared for push buttons in a standard design. They make handling much easier and give a clean and tidy installation.

The post is equipped with a cover plate that doubles up as a guard against accidental activation.

The post comes in widths of Classic 50x50 and Premium 70x70 mm, and heights of 2000 and 2300 mm.



## Posts

Art.no	Gap to floor (mm)	Height (mm)
--------	-------------------	-------------

### Classic 50x50 mm, Yellow (RAL 1018), Black (RAL 9011), Blue (RAL 5005) Red (RAL 3020)

P11-140 (RAL 1018)	100	1400
P21-140 (RAL 5005)	100	1400
P31-140 (RAL 9011)	100	1400
P71-140 (RAL 3020)	100	1400
P11-200 (RAL 1018)	100	2000
P21-200 (RAL 5005)	100	2000
P31-200 (RAL 9011)	100	2000
P71-200 (RAL 3020)	100	2000
P11-230 (RAL 1018)	100	2300
P21-230 (RAL 5005)	100	2300
P31-230 (RAL 9011)	100	2300
P71-230 (RAL 3020)	100	2300

### Classic 50x50 mm, Yellow (RAL 1018)

P11-150	200	1500
---------	-----	------

### Premium 70x70 mm, Yellow (RAL 1018), Red (RAL 3020)

P13-140 (RAL 1018)	100	1400
P73-140 (RAL 3020)	100	1400
P13-200 (RAL 1018)	100	2000
P73-200 (RAL 3020)	100	2000
P13-230 (RAL 1018)	100	2300
P73-230 (RAL 3020)	100	2300

### Extension 50x50 mm, Yellow (RAL 1018), Black (RAL 9011), Blue (RAL 5005), Red (RAL 3020)

E11-075, E11-075B (RAL 1018)	0750	
E21-075, E21-075B (RAL 5005)		0750
E31-075, E31-075B (RAL 9011)		0750
E71-075, E71-075B (RAL 3020)		0750

### Extension Premium 70x70 mm, Yellow (RAL 1018), Red (RAL 3020)

E13-075 (RAL 1018)	0750
E73-075 (RAL 3020)	0750
E13-130 (RAL 1018)	1300
E73-130 (RAL 3020)	1300
E13-190 (RAL 1018)	1900
E73-190 (RAL 3020)	1900
E13-220 (RAL 1018)	2200
E73-220 (RAL 3020)	2200

### Post, push buttons, Yellow (RAL 1018)

50x50 P11-200-A01	2000
50x50 P11-230-A01	2300
70x70 P13-200-A01	2000
70x70 P13-230-A01	2300

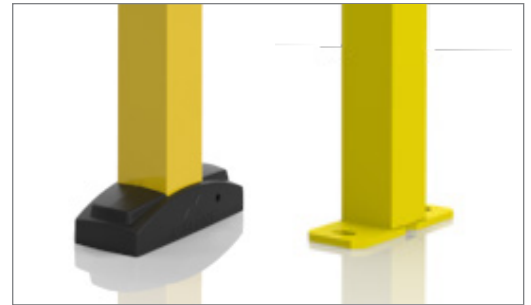

#### Foot Classic 50x50 mm

The Classic 50x50 post comes with a foot cover to hide the welded foot. Top plug and expansion bolt for floor fixing included. Floor gap 100 mm.



#### Foot Premium 70x70 mm

The Premium 70x70 post includes a black powder coated foot. It can be fitted at four different angles. Top plug and expansion bolt for floor fixing included. Floor gap 100 mm.



#### Post, push buttons

The post (Classic 50x50 or Premium 70x70) is prepared for up to 5 push buttons (not included). It is also equipped with a cover plate that doubles up as a guard against accidental activation.



## X-Guard® Lite

X-Guard Lite is a simpler version of X-Guard. An excellent cost-effective alternative offering ample protection when the safety requirements are not as stringent.

### Product facts mesh panels

Safety distance	200 mm
Uprights	19x19 mm
Horizontals	15x15 mm
Posts	50x50 mm
Vertical wires	Ø 3 mm
Horizontal wires	Ø 2.5 mm
Mesh apertures	cc 50x30 mm
Finish	Phosphatising/Epoxy paint
Colour mesh panels	Black RAL 9011
Colour post	Yellow RAL 1018

*(Other colors can be quoted)*



### Mesh panels Lite

Art.no	Height (mm)	Width (mm)
--------	-------------	------------

#### Black (RAL 9011)

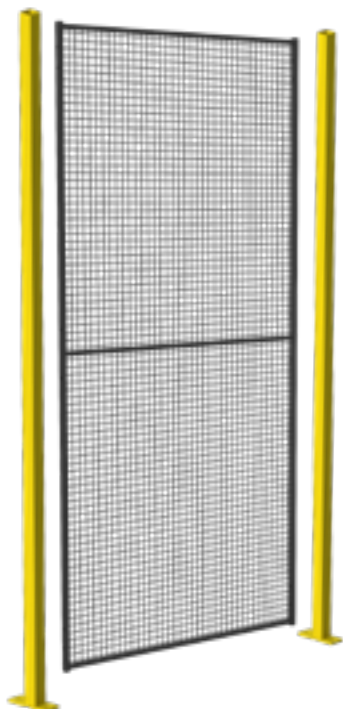

W312-130025	1300	0250
W312-130040	1300	0400
W312-130050	1300	0500
W312-130060	1300	0600
W312-130070	1300	0700
W312-130080	1300	0800
W312-130090	1300	0900
W312-130100	1300	1000
W312-130110	1300	1100
W312-130120	1300	1200
W312-130130	1300	1300
W312-130140	1300	1400
W312-130150	1300	1500

W312-190025	1900	0250
W312-190040	1900	0400
W312-190050	1900	0500
W312-190060	1900	0600
W312-190070	1900	0700
W312-190080	1900	0800
W312-190090	1900	0900
W312-190100	1900	1000
W312-190110	1900	1100
W312-190120	1900	1200
W312-190130	1900	1300
W312-190140	1900	1400
W312-190150	1900	1500

W312-220025	2200	0250
W312-220040	2200	0400
W312-220050	2200	0500
W312-220060	2200	0600
W312-220070	2200	0700
W312-220080	2200	0800
W312-220090	2200	0900
W312-220100	2200	1000
W312-220110	2200	1100
W312-220120	2200	1200
W312-220130	2200	1300
W312-220140	2200	1400
W312-220150	2200	1500

### Posts Lite

Art.no	Gap to floor (mm)	Height (mm)
--------	-------------------	-------------

Lite, 50x50 mm, Yellow (RAL 1018)

P17-140	100	1400
P17-200	100	2000
P17-230	100	2300

### Accessories

Art.no	Description
--------	-------------

K1-02	Kit for optional placing of quick fittings, 1 pack
KHE-3-150	Cutting package "horizontal", RAL 9011
T90-06	X-Guard Lite sample kit
10-9965	Plastic plug 19x19 mm, black
S-0165-03	Vertical cutting package, X-Guard Lite, H = 2200 mm
S-0165-06	Vertical cutting package, X-Guard Lite, H = 1900 mm



## X-Guard® – Doors

X-Guard's door pack gives you easy and safe passage to and from the enclosed area. Whether you need to shift goods in and out or need access to carry out maintenance and service, X-Guard has doors to cover most eventualities. X-Guard is so versatile that you can swap a fixed panel for a door easily without having to move any posts. You do not need to concern yourself with whether the door should be left or right-hinged either (not X-Lock and X-It).

Our door packages can cover a variety of dimensions when paired with the required panel sizes. If you are swapping a fixed panel for a door just add a door package. If you are creating a door from scratch ensure you select the panels and posts you need too.

Doors (Classic 50x50 posts)

Art.no	Height (mm)	Max width (mm)*	Description
D10-XXX150A	Max 2300	1500	Single hinge door with top frame
D10-XXX150B	Min 2300	1500	Single hinge door with top frame
D11-XXX150A	Max 2300	1500	Single hinge door without top frame
D11-XXX150B	Min 2300	1500	Single hinge door without top frame
D12-140300	1400	2 x 1500	Double hinge door
D12-200300	2000	2 x 1500	Double hinge door
D12-230300	2300	2 x 1500	Double hinge door
D12-275300	2755	2x1500	Double hinge door
D12-305300	3055	2x1500	Double hinge door
D20-XXX100A	Max 2300	900	Single sliding door
D20-XXX100B	Min 2300	900	Single sliding door
D20-XXX140A	Max 2300	1400	Single sliding door
D20-XXX140B	Min 2300	1400	Single sliding door
D20-XXX220A	Max 2300	2100	Single sliding door
D20-XXX220B	Min 2300	2100	Single sliding door
D20-XXX310A	Max 2300	3000	Single sliding door
D20-XXX310B	Min 2300	3000	Single sliding door
D20-XXX570A	Max 2300	5700	Single sliding door
D20-XXX570B	Min 2300	5700	Single sliding door
D22-XXX290A	Max 2300	2900	Sliding door with centre lock
D22-XXX290B	Min 2300	2900	Sliding door with centre lock
D22-XXX590A	Max 2300	5900	Sliding door with centre lock
D22-XXX590B	Min 2300	5900	Sliding door with centre lock
D23-200300R	Min 2000	2 x 1500	Double sliding door, right, with 2-step rail
D23-200300L	Min 2000	2 x 1500	Double sliding door, left, with 2-step rail
D23-230300R	Min 2300	2x1500	Double sliding door, right, with 2-step rail
D23-230300L	Min 2300	2 x 1500	Double sliding door, left, with 2-step rail
D23-200450R	Min 2000	3 x 1500	Triple sliding door, right, with 3-step rail
D23-200450L	Min 2000	3 x 1500	Triple sliding door, left, with 3-step rail
D23-230450R	Min 2300	3 x 1500	Triple sliding door, right, with 3-step rail
D23-230450L	Min 2300	3 x 1500	Triple sliding door, left, with 3-step rail
D24-200140	2000	2 x 1400	Double sliding door
D24-230140	2300	2 x 1400	Double sliding door
D24-200290	2000	2 x 2900	Double sliding door
D24-230290	2300	2 x 2900	Double sliding door
D26-XXX090	Max 2300	0900	Single sliding door without rail
D26-XXX140	Max 2300	1400	Single sliding door without rail
D27-XXX180	Max 2300	1800	Double sliding door without rail
D27-XXX280	Max 2300	2800	Double sliding door without rail
D28-140190L	1400	1900	Single sliding door without rail left
D28-140190R	1400	1900	Single sliding door without rail right
D28-140290L	1400	2900	Single sliding door without rail left
D28-140290R	1400	2900	Single sliding door without rail right
D28-200190L	2000	1900	Sliding door without rail left
D28-200190R	2000	1900	Sliding door without rail right
D28-200290L	2000	2900	Sliding door without rail left
D28-200290R	2000	2900	Sliding door without rail right
D28-230190L	2300	1900	Sliding door without rail left
D28-230190R	2300	1900	Sliding door without rail right
D28-230290L	2300	2900	Sliding door without rail left
D28-230290R	2300	2900	Sliding door without rail right
D29-XXX380	Max 2300	2x1900	Sliding door without rail, centre lock
D29-XXX480	Max 2300	1x2900+1x1900	Sliding door without rail, centre lock
D29-XXX580	Max 2300	2x2900	Sliding door without rail, centre lock

(Standard panels are used for doors)

\* The maximum width varies depending on the used locking solution

» Cont. from previous page

Doors (Premium 70x70 posts)			
Art.no	Height (mm)	Max width (mm)*	Description
D30-XXX150A	2300	1500	Single hinge door, incl. top frame
D30-XXX150B	2300	1500	Single hinge door, incl. top frame
D32-200300	2000	Max 2x1500	Double hinge door
D32-230300	2300	Max 2x1500	Double hinge door
D32-275300	2755	Max 2x1500	Double hinge door
D32-305300	3055	Max 2x1500	Double hinge door
D40-XXX100A	Max 2300	900	Single sliding door
D40-XXX100B	Min 2300	900	Single sliding door
D40-XXX140A	Max 2300	1400	Single sliding door
D40-XXX140B	Min 2300	1400	Single sliding door
D40-XXX220A	Max 2300	2100	Single sliding door
D40-XXX220B	Min 2300	2100	Single sliding door
D40-XXX310A	Max 2300	3000	Single sliding door
D40-XXX310B	Min 2300	3000	Single sliding door
D40-XXX570A	Max 2300	5700	Single sliding door
D40-XXX570B	Min 2300	5700	Single sliding door
D42-XXX290A	Max 2300	2900	Sliding door with centre lock
D42-XXX290B	Min 2300	2900	Sliding door with centre lock
D42-XXX590A	Max 2300	5900	Sliding door with centre lock
D42-XXX590B	Min 2300	5900	Sliding door with centre lock
D43-200300L	2000	Max 2x1500	Sliding door, left with 2-step rail
D43-200300R	2000	Max 2x1500	Sliding door, right with 2-step rail
D43-200450L	2000	Max 3x1500	Sliding door, left with 3-step rail
D43-200450R	2000	Max 3x1500	Sliding door, right with 3-step rail
D43-230300L	2300	Max 2x1500	Sliding door, left with 2-step rail
D43-230300R	2300	Max 2x1500	Sliding door, right with 2-step rail
D43-230450L	2300	Max 3x1500	Sliding door, left with 3-step rail
D43-230450R	2300	Max 3x1500	Sliding door, right with 3-step rail
D44-200140	2000	Max 2x1400	Double sliding door overlapped
D44-200290	2000	Max 2x2900	Double sliding door overlapped
D44-230140	2300	Max 2x1400	Double sliding door overlapped
D44-230290	2300	Max 2x2900	Double sliding door overlapped
D46-XXX090	Max 2300	900	Sliding door without rail
D46-XXX140	Max 2300	1400	Sliding door without rail
D46-XXX290	Max 2300	2900	Sliding door without rail
D47-XXX580	Max 2300	2x2900	Sliding door without rail with centre lock
D57-XXX400A	Max 2300	4000	Hinged/sliding door with centre lock
D57-XXX400B	Min 2300	4000	Hinged/sliding door with centre lock

(Standard panels are used for doors)

\* The maximum width varies depending on the used locking solution

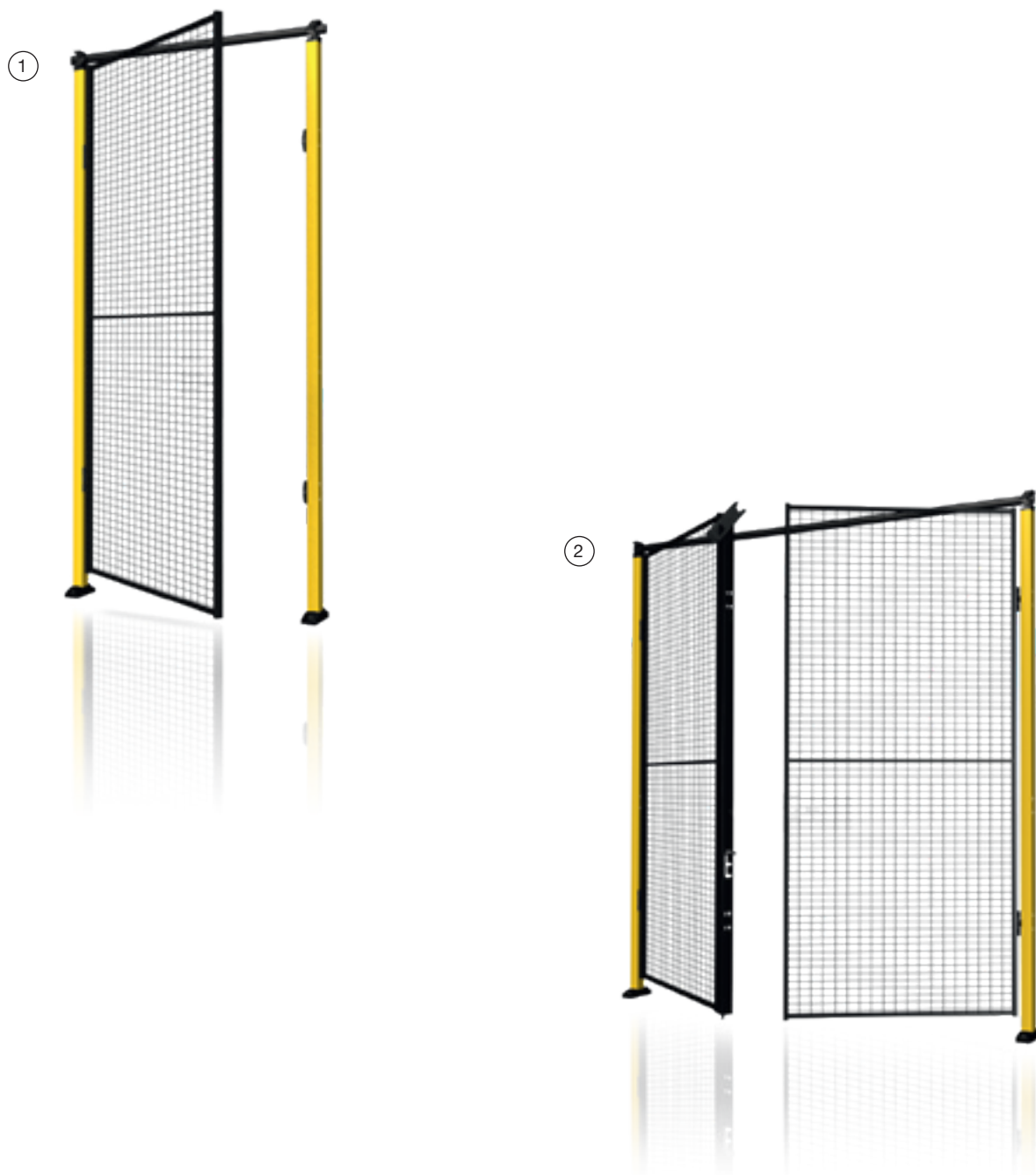

## X-Guard<sup>®</sup> - Hinge Doors

- ① Single hinge door, max opening 1500 mm.
- ② Double hinge door, access for wider goods, pallet truck etc max opening 2x1500 mm.

③



④



## X-Guard® - Sliding Doors

- ③ Sliding door with centre lock, where the door blades are pushed in opposite directions. Maximum width is 5900 mm.
- ④ Single sliding door, can be built with a max opening of 5700 mm.





- ⑤ Double sliding door, for cramped areas and for two feed positions from the machine. Available in sizes up to 2x2900 mm.
- ⑥ Single sliding door without rail, has an opening of three meters and no upper limitations. The door is perfect when handling large volumes carried by overhead crane or forklift. Maximum width 3000 mm and maximum height 2300 mm.

⑦

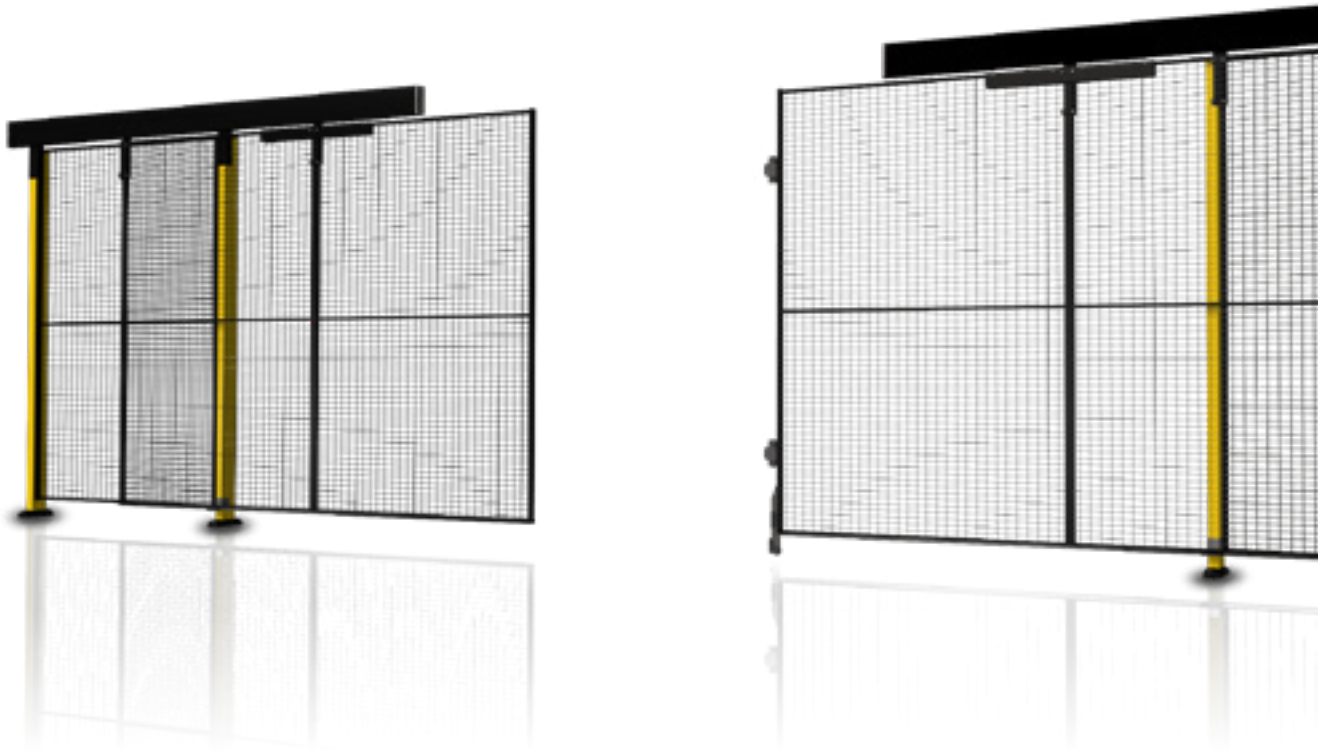

⑧

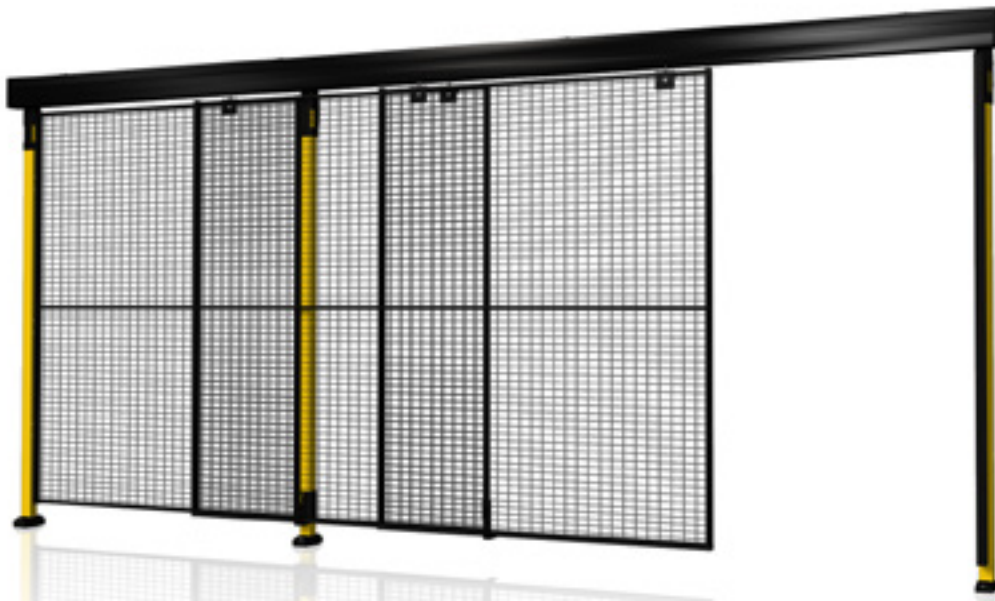

## X-Guard® - Sliding Doors

- ⑦ Double sliding without rail, has an opening of 6 meters and no upper limitation. The door is perfect when handling large volumes carried by overhead crane or forklift. Maximum width 2x3000 mm and maximum height 2300 mm.
- ⑧ Double sliding door with 2-step rail, is used where a large opening is required but where there is limited space at the side. The panels overlap each other instead of sliding to the side. Maximum width 2x1500 mm and maximum height 2300 mm.



⑨

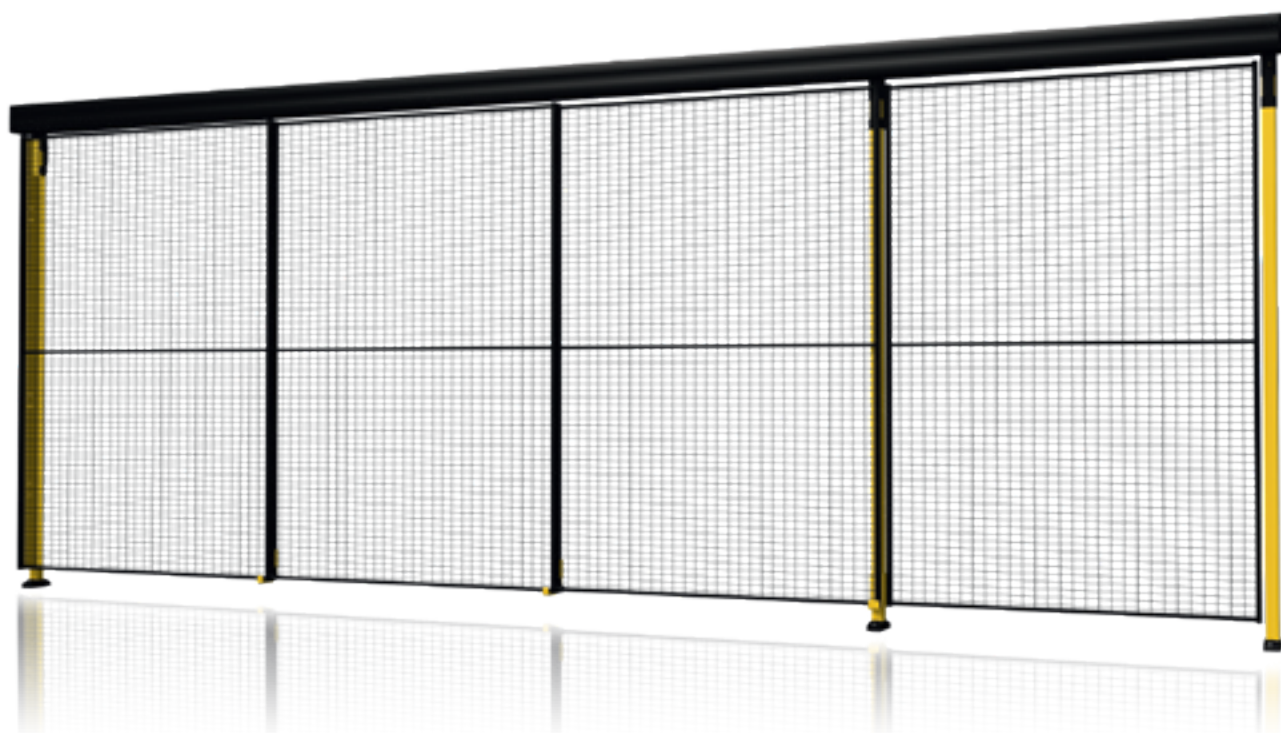

- ⑨ Triple sliding door with 3-step rail, is used where a large opening is required but where there is limited space at the side. The panels overlap each other instead of sliding to the side. Maximum width 3x1500 mm and maximum height 2300 mm.

10

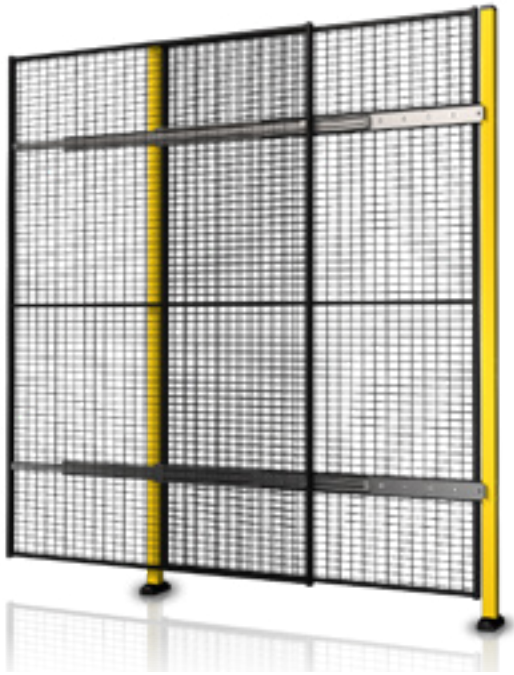

11

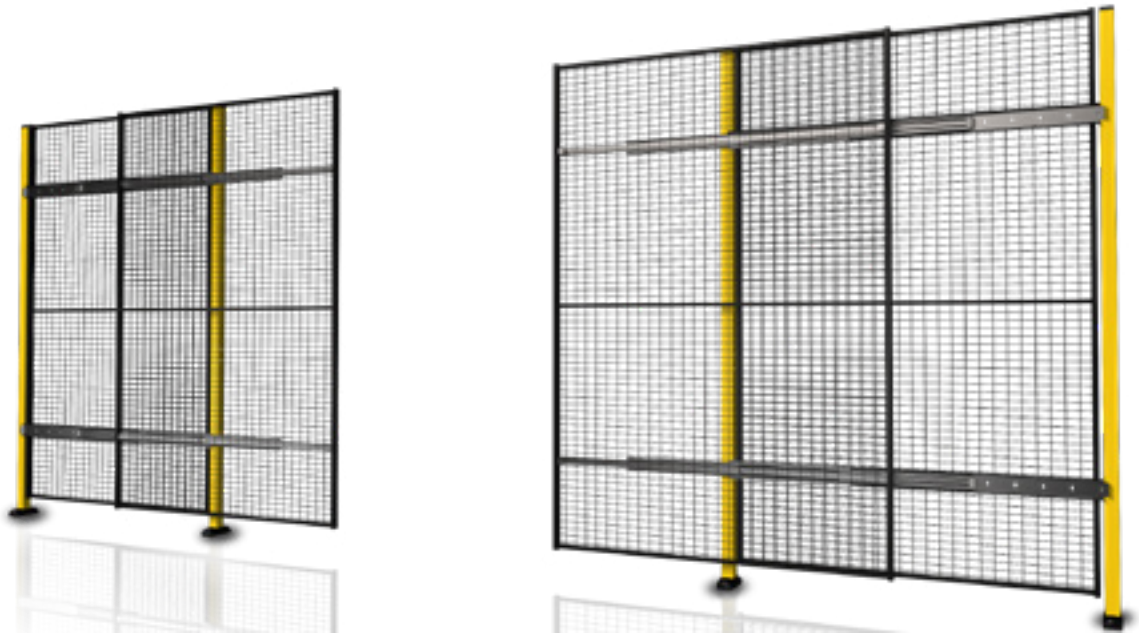

## X-Guard® - Sliding Doors

- ⑩ Single sliding door without rail. An ideal solution for an opening with no overhead obstruction and where the need for a large opening isn't necessary. Maximum widths 900 mm and 1400 mm, maximum height 2300 mm.
- ⑪ Double sliding door without rail, with centre lock. An ideal solution for an opening with no overhead obstruction and where the need for a large opening isn't necessary. Maximum widths 1800 mm and 2800 mm, maximum height 2300 mm.

⑫

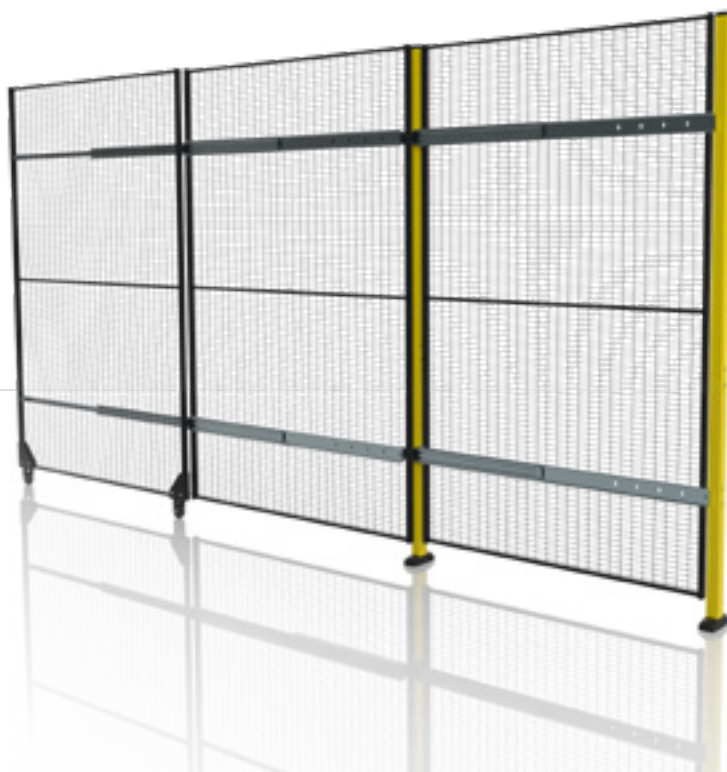

⑬

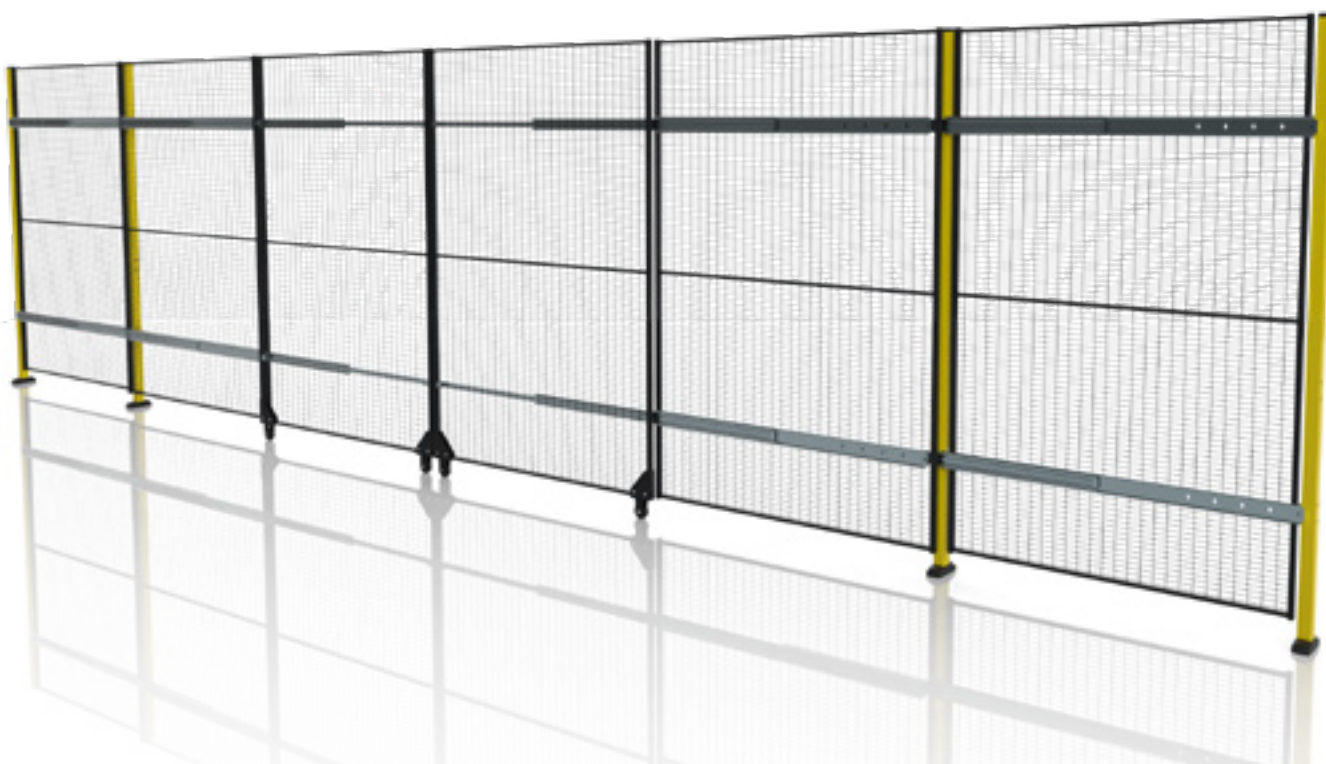

- ⑫ Single sliding door without rail. An ideal solution for an opening with no overhead obstruction and where the need for a large opening is necessary. Maximum widths 1900 mm and 2900 mm, maximum height 2300 mm.
- ⑬ Sliding doors without rail, with centre lock. An ideal solution for an opening with no overhead obstruction and where the need for a large opening is necessary. Maximum widths 3800 mm, 4800 and 5800 mm, maximum height 2300 mm.



## X-Guard<sup>®</sup> – Locks

Axelent's X-Guard has flexible locking systems to suit all doors and switches/switch fittings in the machine guard series, from simple to more high tech solutions. X-Guard is so versatile in fact that you can swap a fixed panel for a door easily without having to move any posts. Combine a door pack with a locking system and create a door and locking solution to suit your needs.

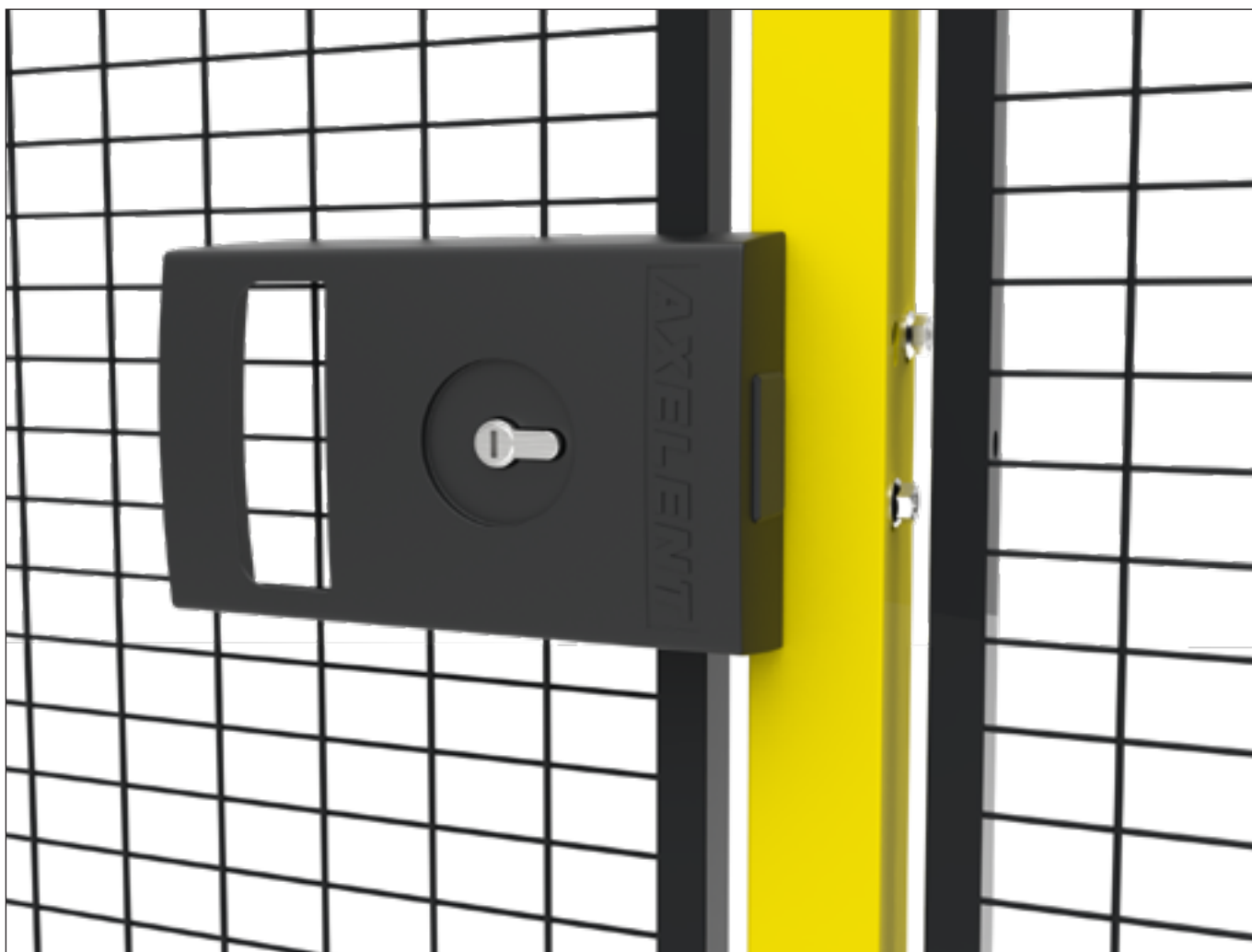

## X-It

Axellent X-It is a patent-pending, ingenious cylinder lock with a unique design that requires no extra case. The lock is designed for X-Guard, but also suits Axellent's other industrial and warehouse mesh partitioning systems. The ingenious design, easy fitting, and versatility makes X-It perfect for use with other 3rd party mesh products and systems on the market. The lock is suited to both hinged and sliding doors.

It has a robust metal case that withstands tough handling and is tested and approved in compliance with SS-EN 12209:2016.

Advanced evacuation function. The lock can be combined with a mechanical panic / evacuation module.

X-It	
Art.no	Description
XIT-L01-101	Cylinderlock X-It compl, left mech, hinge door, X-Guard
XIT-L01-301	Cylinderlock X-It compl, left mech, single sliding door, X-Guard
XIT-L01-401	Cylinderlock X-It, left mech, slidingdoor with centrelock, X-Guard
XIT-L02-101	Cylinderlock X-It compl, left mech + panic, hinge door, X-Guard
XIT-R01-101	Cylinder lock X-It compl, right mech, hinge door, X-Guard
XIT-R01-301	Cylinder lock X-It compl, right mech, single sliding door, X-Guard
XIT-R01-401	Cylinderlock X-It, right mech,slidingdoor with centrelock, X-Guard
XIT-R02-101	Cylinderlock X-It compl, right mech + panic, hinge door, X-Guard
XIT-L02-301	Cylinderlock X-It compl, left mech + panic, sliding door, X-Guard
XIT-L02-401	Cylinderlock X-It compl, left mech + panic, sliding door center lock, X-Guard
XIT-R02-301	Cylinderlock X-It compl, right mech + panic, sliding door, X-Guard
XIT-R02-401	Cylinderlock X-It compl, right mech + panic, sliding door center lock, X-Guard

# X-Guard® – Locks



## Padlock brackets

Our most simple lock system. A normal hinge lock secure the area from being entered by unauthorized.



## Snap lock

The door closes with a simple push and is kept closed by the built-in catch.

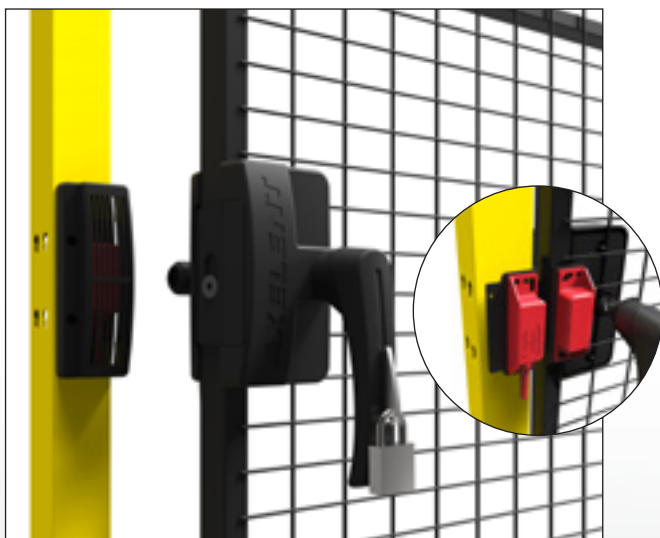

## Hitch lock

This lock is an alternative to our X-lock and has an integrated mounting for non-contact switches. The lock has an adjustable hitch for eliminating any internal play. The handle is spring-loaded to remove the ability of the door to automatically fully close. To fully shut the door requires deliberate operation of the handle eliminating accidental closure. The external handle has an integrated padlock-loop which makes it possible to secure the door to prevent accidental closure when servicing or machine setting for example.

*Note, padlock and/or switch are not included.*

## Locks

Art.no	Description
L10-00-0	Padlock brackets for hinge door, right/left
L20-00-0	Padlock brackets for sliding door, right/left
L22-00-0	Padlock brackets for sliding door with centre lock
L10-05-0	Snap lock for hinge door, right/left
L20-05-0	Snap lock for sliding door, right/left
L22-05-0	Snap lock for sliding door with centre lock
L10-05-2	Hitch lock for hinge doors right/left
L20-05-2	Hitch lock for sliding doors right/left
L10-05-3	Cylinder lock, option for the handle to the hitch lock (1 each)
L66-20-L	X-Lock for all doors, left
L66-20-R	X-Lock for all doors, right
L66-21-L	X-Lock for all doors, left,for switch B-614
L66-21-R	X-Lock for all doors, right,for switch B-614
10-9540	Eurocylinder, DIN 18254, class 3
10-9545	Eurocylinder, DIN 18254, in system
10-9550	Eurocylinder (half), DIN V 18254
10-9551	Eurocylinder (half), DIN V 18254, in system



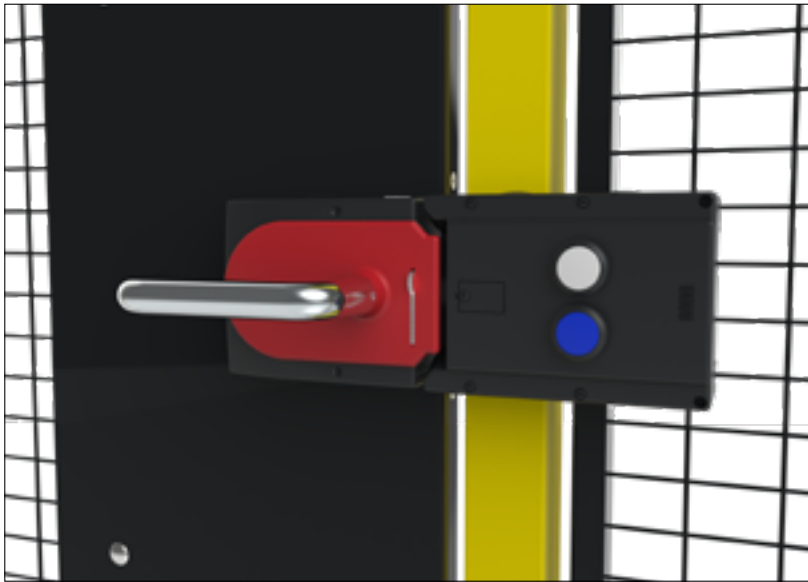

### Euchner MGB

The MGB (Multifunctional Gate Box) is a unique inter- and guard locking system for the protection of safety doors on machines and systems. Four LEDs indicate information about the lock status.

The lock has an intelligent plunge whose position is detected by an RFID transponder which has a unique code. This prevents tampering while allowing the MGB meets PL e EN ISO 13849-1 / SIL 3 according to EN 62061.



### X-It Panic lock

Axelent X-It is a keyed cylinder lock. The lock is a unique design that requires no additional lock housing, just add a standard cylinder such as Euro. The lock is robust with a cover in metal to withstand tough conditions, and is tested and approved according to SS-EN 12209:2016. X-It fits for both hinge or sliding doors.

A lock with cylinder can be used as an emergency exit and means of escape where maintenance access is required. Doors with panic lock can always be opened from the inside, even when locked by key from the exterior.

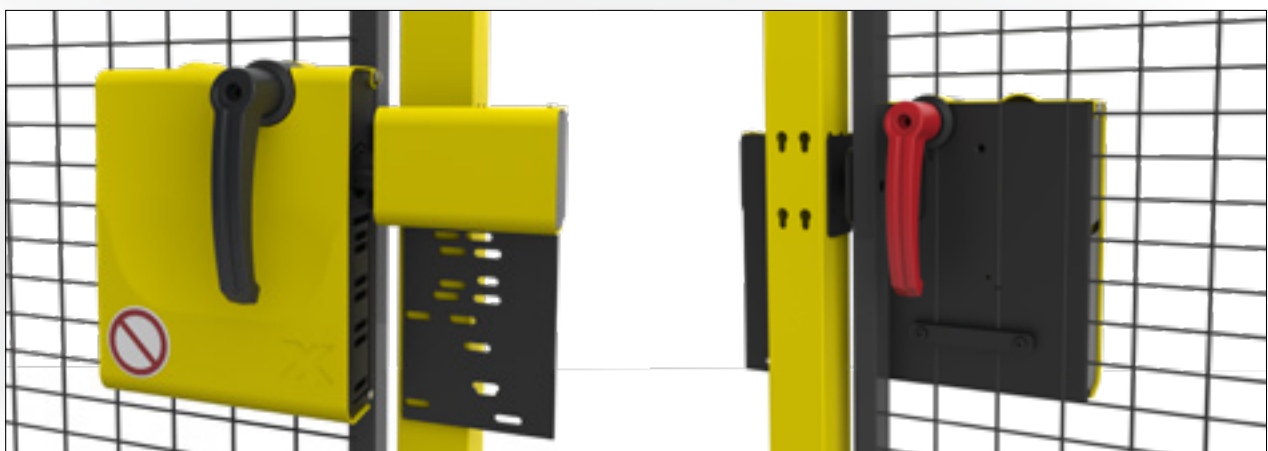

### X-Lock

X-Lock is a versatile door lock system that suits all our accident prevention series. Using X-Lock and a door kit, you can transform any accident prevention panel into a door with a secure locking function.

X-Lock has a mechanical bolt that holds hinged and sliding doors closed. The lock is designed so that it requires conscious action to open and close the door from the outside. From the inside, X-Lock can not be closed. When locked, X-Lock can be opened from inside, unless a switch with guard locking is installed additionally.

## Safety switches

Art.no	Description
T10-01	Complete fittings for switch and key, hinge door, right/left
T10-02	Complete fittings for switch and key, sliding door, right/left
T10-12	Complete fittings for switch and key, hinge doors, right/left, Euchner
T10-13	Switch fitting hinge door, universal, non-contact
T10-20	Complete fittings for switch and key, sliding doors, right/left
T10-23	Switch fitting single sliding door, universal, non-contact
T10-24	Switch fitting meeting sliding door, universal, non-contact
T10-30	Fittings, Euchner MGB hingedoor/slidingdoor, right/left
T10-31	Extra fittings for Euchner MGB with panic handle Ra9011, X-Guard
T10-32	Fittings, Schmersal AZM200 hingedoor/slidingdoor, right/left
T10-33	Fittings, Euchner MGB Profinet Box hingedoor, right/left
T10-34	Fittings, Euchner MGB Profinet Box slidingdoor, right/left
T10-35	Extra MGB bracket, sliding door with centre locking, X-Guard



**T10-01**

Complete fittings for switch and key, hinge door, right/left

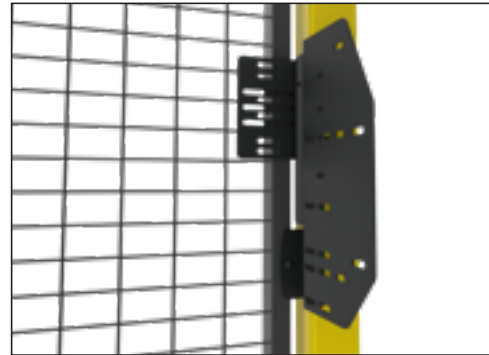

**T10-12**

Complete fittings for switch and key, hinge doors, right/left, Euchner



**T10-13**

Switch fitting hinge door, universal, non-contact

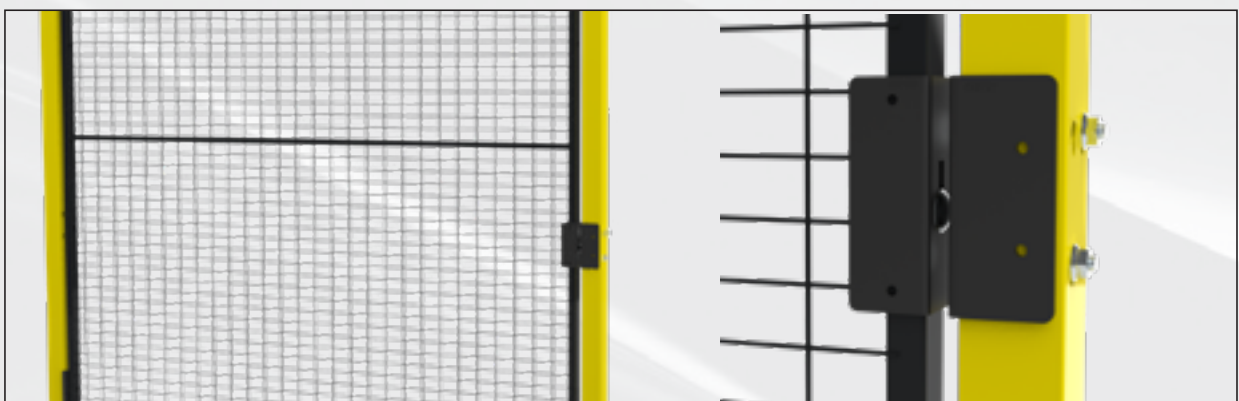

**T10-30**

Euchner MGB hinge door, right/left

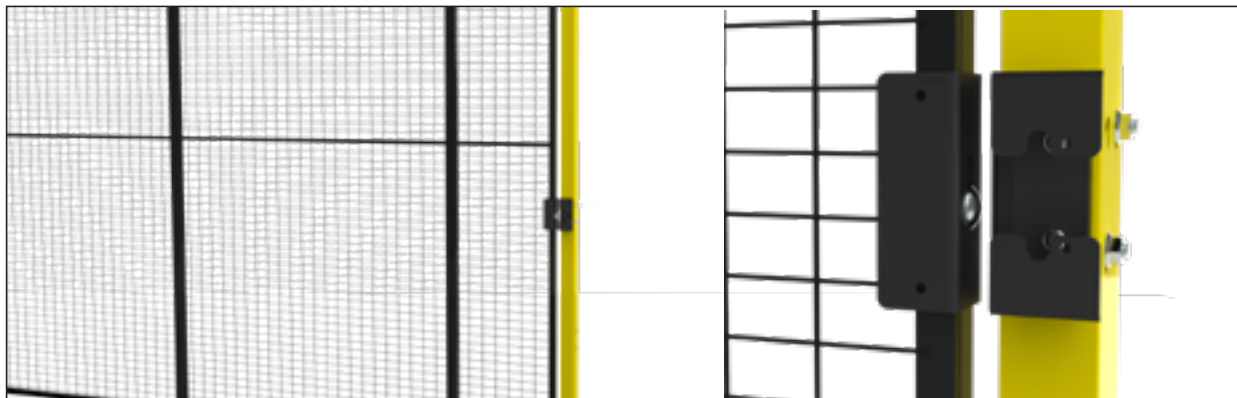
**T10-30**

Fittings, Euchner MGB slidingdoor, right/left

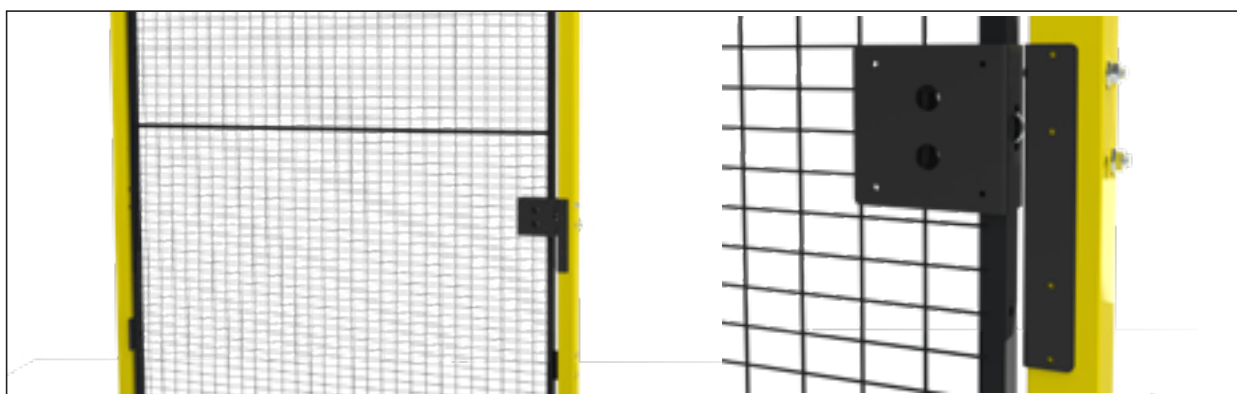
**T10-32**

Fittings, Schmersal AZM200 hingedoor, right/left

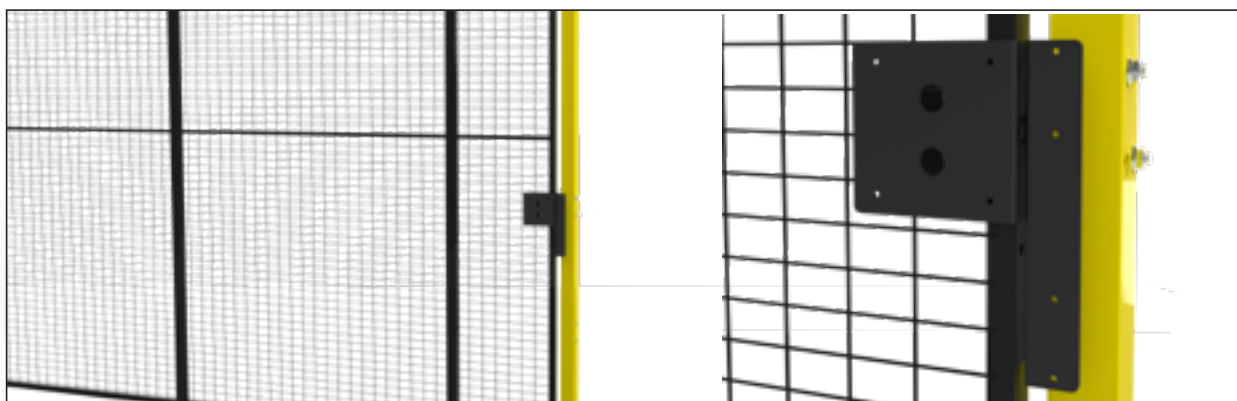
**T10-32**

Fittings, Schmersal AZM200 slidingdoor, right/left

**Switch/Emergency Stop**

Axellent collaborates with several market leaders within the sector, including Allen-Bradley GuardMaster, Euchner, ABB Jokab, Telemecanique and Siemens. This gives us a wide range to offer our customers for the safest and most optimum solution possible.

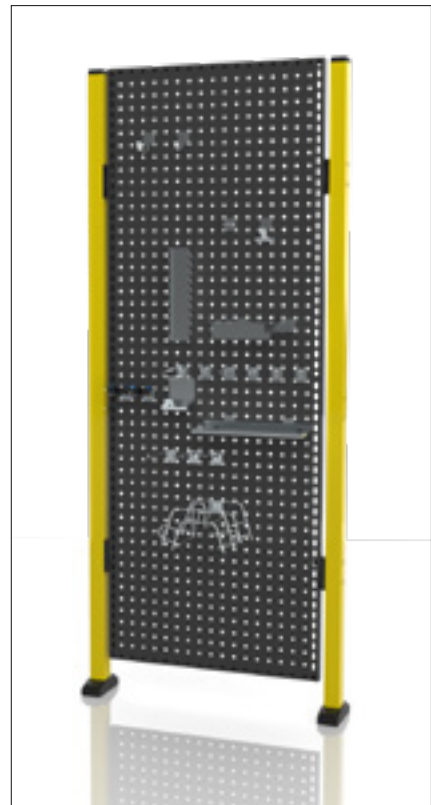

**X3-242-7 / X3-244-7 Tool Panel**

X-Guard's Tool Panel enables you to keep all your tools and accessories needed to manage your machinery close at hand. The panel comes in heights of 1900 and 2200 mm and is 700 mm in width. The standard colour is RAL 9011. A host of accessories are available for hanging up tools.

*More info and product sheets are available at [www.axelent.com](http://www.axelent.com).*

## X-Guard® – Accessories

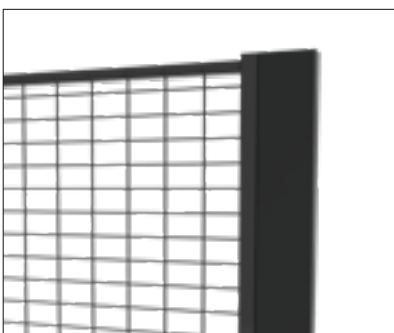

**Infill sheet metal** (Art No. see page 31)

An infill sheet metal functions as a filler when a guard needs a certain width. It comes in all heights and in 40 and 70 mm widths. Standard colour is RAL 9011 but customised colours are available upon request.



**Adjustable infill** (Art No. see page 31)

This adjustable infill piece covers gaps between 40 and 145 mm, offering greater flexibility. The 100 mm interval between our panels means less cutting of panels when an 'odd' gap needs to be filled. A stock item in Ral 9011, but other colours are available on request.



**Cover strip** (Art No. see page 31)

Strip to cover the gap between the post and panel. A black cover strip (RAL 9011) is included with sheet metal and plastic panels. It comes in heights of 750, 1900 and 2200 mm.



**T01-23 Support wheel**

An extra support wheel would not go amiss on some types of door solutions. Our range now includes a new smart support wheel that fits both hinged and sliding doors.



**T01-27 Door closer**

Automatic door closer for X-Guard's hinged door, including fittings. The fittings are reversible and suit both 50x50 and 70x70 mm posts.

*NB There is some risk in using automatic door closers in combination with an interlock without manual reset. Door closers must therefore be evaluated in each individual case.*



**T01-05 Top frame fittings for doors in corners**

A top frame fitting provides a more stable door construction for your machine guard. The width of the fitting is set during assembly. Top frame fittings are used for positioning two doors in a corner.



**T01-22 Bail handle**

Bail handle c/c 150 mm, set of 2 including mounting plates.

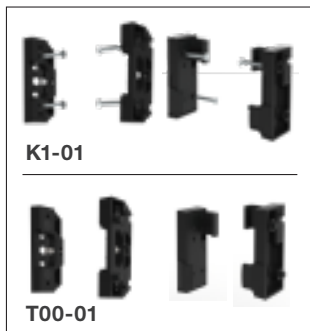

**Quick fittings (Art No. see page 31)**

A selection of brackets are available for X-Guard panels. These allow simple and quick attachment of panels to posts. The quick fittings has a top and a bottom attachment. The top fitting is a simple click-on fitting that can be fitted to three sides of the post. The click-on function means simple and above all quick fitting. Only one fitter is required to fit mesh panels to X-Guard machine guards. The lower fitting acts as a guide to steer the panel into the correct position. The panel is simply clicked into place in the top bracket, when it is in place. A quick fitting is also available for free positioning of the X-Guard post, see picture to the left (K1-01).



**Cutting package (Art No. see page 31)**

Panels may need to be cut to precise heights and widths in some environments. The X-Guard cutting pack will help you cut panels and is available in both vertical and horizontal versions.

The vertical comes in four heights; 750, 1300, 1900 and 2200 mm. The horizontal only comes in 1500 mm but is compatible with all widths and is available with or without attachments to allow unrestricted positioning. The standard cutting pack colour is black (RAL 9011) but customised colours are available upon request.

A rubber strip can be fitted to provide a soft and neat edge where mesh panels have been cut.

# X-Guard® – Accessories



## T01-13 / T01-17 Rubber plugs

Black rubber plugs can be used to cover unused holes in the post.



## T01-06 Tube nut M8 (10-pack)

Tube nut M8 – This nut can be used when you have cut a panel and need to drill a new hole.



## T01-28 Special nut (10-pack)

Nut plate set, for the top plug on the 50x50 mm post.



## T01-08 Magnet

For use with 'Snap' close door locks.



## T00-00 X-Key

A unique key for quick panel release. X-Guard panels can only be dismantled using an X-Key (All panel and post orders include a key).

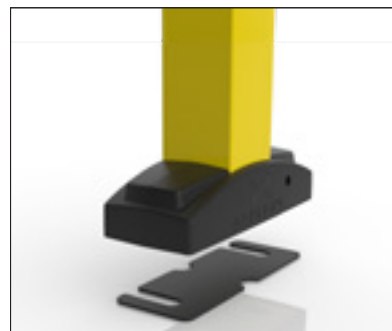

## T01-04 (50x50) / T01-25 (70x70) Shims set

Used for adjusting the height of X-Guard posts where the floor is uneven. There are two different keys depending on the type of post you choose.

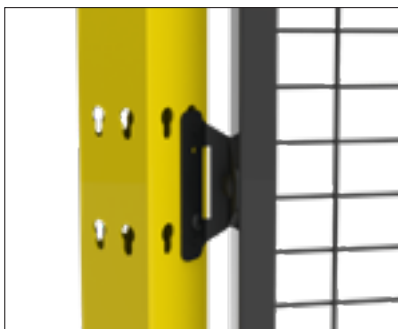

## T01-01 0-180° Fitting

Fitting with an angle of up to 180°. This fitting is used where the machine guard needs to be set up at angles other than 90°.

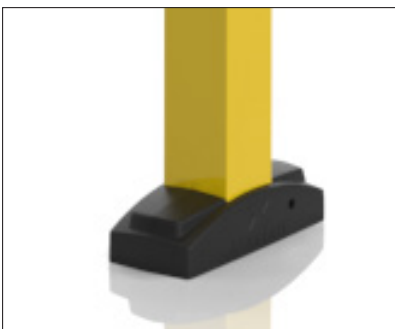

## T01-16 Foot cover

This foot cover consists of two pieces that are simply attached to each other. A foot cover is always supplied with a 50x50 post (not the 70x70).



## X-Tray for X-Guard

Cable tray which fits X-Guard machine guarding perfectly. See page 32-41.



## T01-07 X-Cup

Smart mug holder to fix to a post. (for 50x50 mm post only)

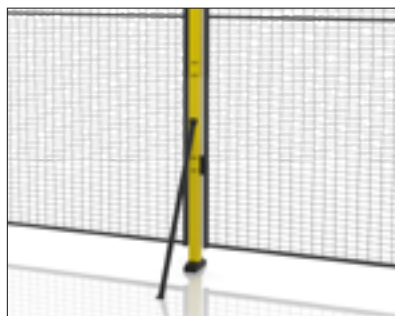

## T01-09 Stabilization for contractor

Stabilization for contractor, RAL 9011.

## Accessories

Art.no	Description
T00-00	X-Key
T00-01	Fittings for X-Guard, 1 pack
T00-02	Fittings for X-Guard, 1 pack, for 4 mm plastic panels
T00-03	Fittings for X-Guard, 1 pack, for 6 mm plastic panels
T00-04	Fittings for X-Guard, 1 pack, for horizontal panels
T00-05	Fittings for X-Guard, 1 pack, for horizontal panels different heights
T01-01	Fittings for creating corners up to 180°
T01-02	High impact protection for 50x50 mm post, 1 set/panel
T01-03	Special nut, for plastic cap on post, X-Guard, 10 pack
T01-04	Shim set, 2x2 mm + 1x6 mm, for post height adjustment X-Guard
T01-05	Special bracket when mounting 2 hinge doors in a corner
T01-06	Tube nut M8, 10 pack
T01-07	X-Cup holder
T01-08	Magnet
T01-09	Stabilization for contractor, Ral 9011
T01-11	Bolt upper panel bracket (zinc), not blocked, 10 pack
T01-13	Rubber plug for "keyhole" on X-Guard post (1set=36pcs)
T01-16	Foot cover for 50x50 post 5 kit (1 kit=2pcs)
T01-17	Top plug for 50x50 post (1 kit=5 pcs)
T01-18	Bracket for optional upper bar in corner, post 70x70mm
T01-19	Bracket for optional upper bar, 1kit/post, post 70x70mm
T01-21	Edge strip u-shaped, black rubber 30x26x15mm, 50m
T01-22	Bail handle c/c 150mm, set of 2 incl. mounting plates
T01-23	Support wheel incl. mounting plate. For floor gap 100mm, X-Guard
T01-24	X-Guard transp. securing kit (=4pcs) pre-assem. door, Classic+50x50mm
T01-25	Shim set for 70x70, 2x2mm + 2x4mm, for post adjustment X-Guard
T01-26	Bail handle c/c 122mm incl. screws for X-It, inside
T01-27	Automatic door closer, X-Guard hinge door
T01-28	Special nut, ver.2, (10 pack) post 50x50mm, X-Guard
T01-29	High impact protection for 70x70 post, 1set/panel, X-Guard
T01-30	Base for portable panel
T02-3-07504	Infill sheet metal H= 0750 W= 40 mm, RAL 9011
T02-3-07507	Infill sheet metal H= 0750 W= 70 mm, RAL 9011
T02-3-13004	Infill sheet metal H= 1300 W= 40 mm, RAL 9011
T02-3-13007	Infill sheet metal H= 1300 W= 70 mm, RAL 9011
T02-3-19004	Infill sheet metal H= 1900 W= 40 mm, RAL 9011
T02-3-19007	Infill sheet metal H= 1900 W= 70 mm, RAL 9011
T02-3-22004	Infill sheet metal H= 2200 W= 40 mm, RAL 9011
T02-3-22007	Infill sheet metal H= 2200 W= 70 mm, RAL 9011
T03-3-190	Cover strip, gap panel/post H= 1900 mm, RAL 9011
T03-3-220	Cover strip, gap panel/post H= 2200 mm, RAL 9011
T04-3-075	Cover strip with clips H= 0750 mm, RAL 9011, 1 set/panel
T04-3-190	Cover strip with clips H= 1900 mm, RAL 9011, 1 set/panel
T04-3-220	Cover strip with clips H= 2200 mm, RAL 9011, 1 set/panel
T05-3-13015	Infill, adjustable 40-145 mm. H =1300 mm complete, Ral 9011
T05-3-19015	Infill, adjustable 40-145 mm. H:1900 mm complete, Ral 9011
T05-3-22015	Infill, adjustable 40-145 mm. H: 2200 mm complete, Ral 9011
T90-01	X-Guard Sample kit
K1-01	Kit for optional placing of quick fittings, 1 pack
K1-03	Kit for optional placing of quick fittings upper bracket X-Guard, 1 pack
KVC-3-075	Cutting package vertical, H= 0750 mm, RAL 9011
KVC-3-130	Cutting package vertical, H= 1300 mm, RAL 9011
KVC-3-190	Cutting package vertical, H= 1900 mm, RAL 9011
KVC-3-220	Cutting package vertical, H= 2200 mm, RAL 9011
KH-3-150	Cutting package horizontal, incl. fittings K1-01, W= 1500 mm, RAL 9011
KH-3-150B	Cutting package horizontal exkl. fittings K1-01, W= 1500 mm, RAL 9011
10-9841	Edge strip u-shaped, black rubber, 2 m
05-9501	Plastic plug 20x30 mm
X3-242-7	Toolpanel X-Guard H=1900 W=700mm, RAL9011
X3-244-7	Toolpanel X-Guard H=2200 W=700mm, RAL9011



SnapperWorks

With SnapperWorks drawing program you get the cables in order right from the start



Keyhole mounting

Top mounting

Cantilever mounting



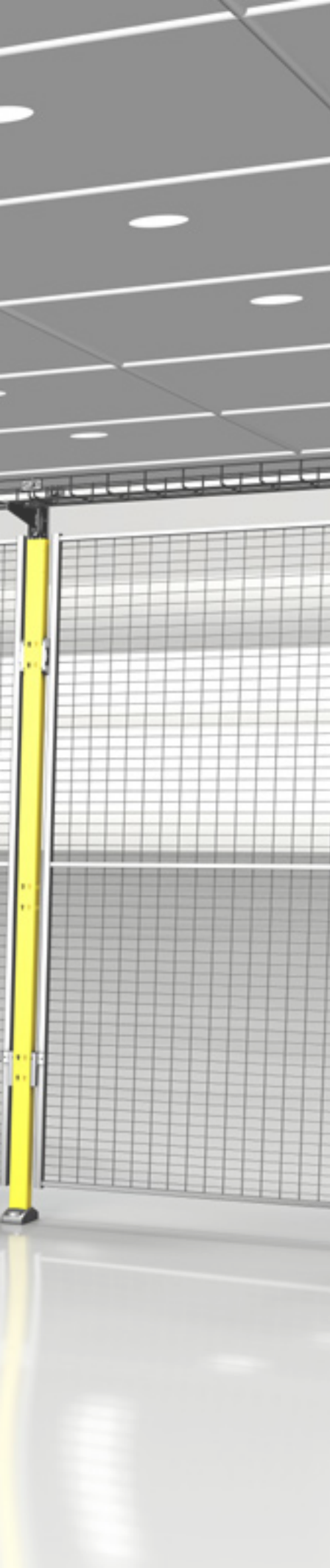

# The finishing touch to your machine safety with X-Tray®

X-Tray cable trays fit our X-Guard machine guard like a glove. Together they provide the optimal solution.

Our cable trays are strong, adaptable and easy to fit. They enable elegant solutions with no special tools required. As with X-Guard, only a few brackets and tools are needed. The combination of X-Tray and X-Guard gives you maximum use of minimum material. A simple but smart touch. The near endless possibilities, despite fewer components, saves you time and money through having everything in one order to complete projects.

### The perfect fit

Axellent's X-Tray is the ideal cable tray for X-Guard machine guard because they are perfectly matched for smooth installation to give a professional touch.

### No special tools required

The combination is easy to assemble without the need for special tools. A 13 mm spanner is all you require.

### One supplier

A turnkey solution from one supplier makes project implementation that much quicker and easier. It is also cost-effective because everything is bundled in the same shipment.

X-Tray

*(These are just three examples, X-Tray offers several different mounting solutions. See page 36)*

X-Tray complies with the highest demands on cable routing systems in



\*Our UL certification also gives us NEMA approval.

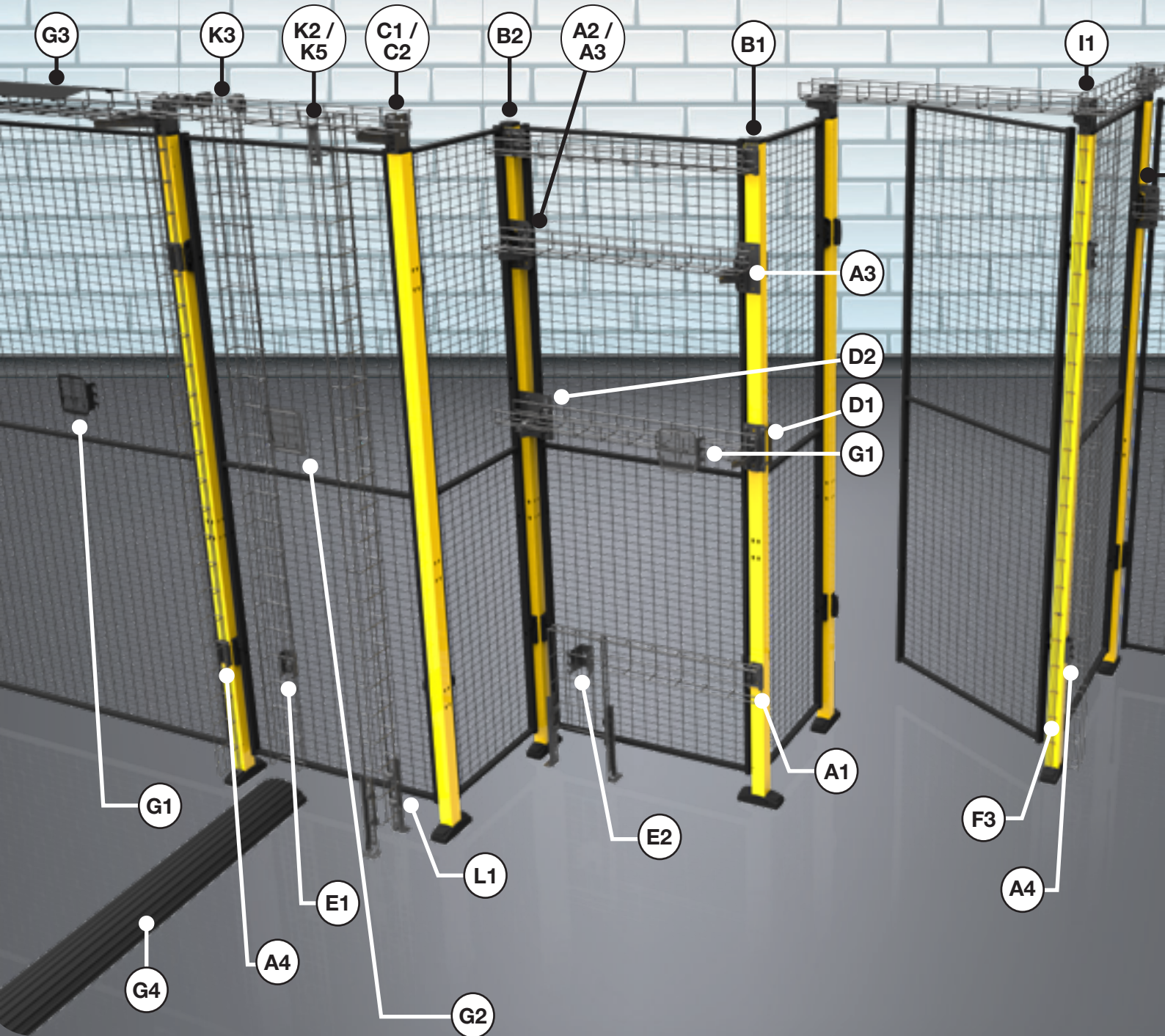



# The possibilities with X-Tray for X-Guard

All cable trays and fittings are black galvanized to match X-Guard's black panels.

## Installations of X-Tray for X-Guard

- Max load: Cable trays 30 kg/m, Brackets 45 kg/each
- Max width of brackets: 420 mm
- X-Tray has the strongest quick joining on the market and the longest support distance of 2.25 m
- For side-hinged doors, X-Tray can replace the tubular frame for a stable installation of cable routing
- More information about X-Tray and fittings is available at [axelent.com](http://axelent.com)

## The three most common installations

- 1 Keyhole mounting**  
For fast installations in the post keyholes. Trays 60-120 mm.
- 2 Top mounting**  
Quick and discrete installation that follows X-Guard's top edge. Trays 60-120 mm.
- 3 Cantilever mounting**  
This option gives a stable installation over the machine guard and most possibilities/solutions. The best solution for several doors/sliding doors. Trays 60-420 mm.

(It is possible to mix all three for the best fit)

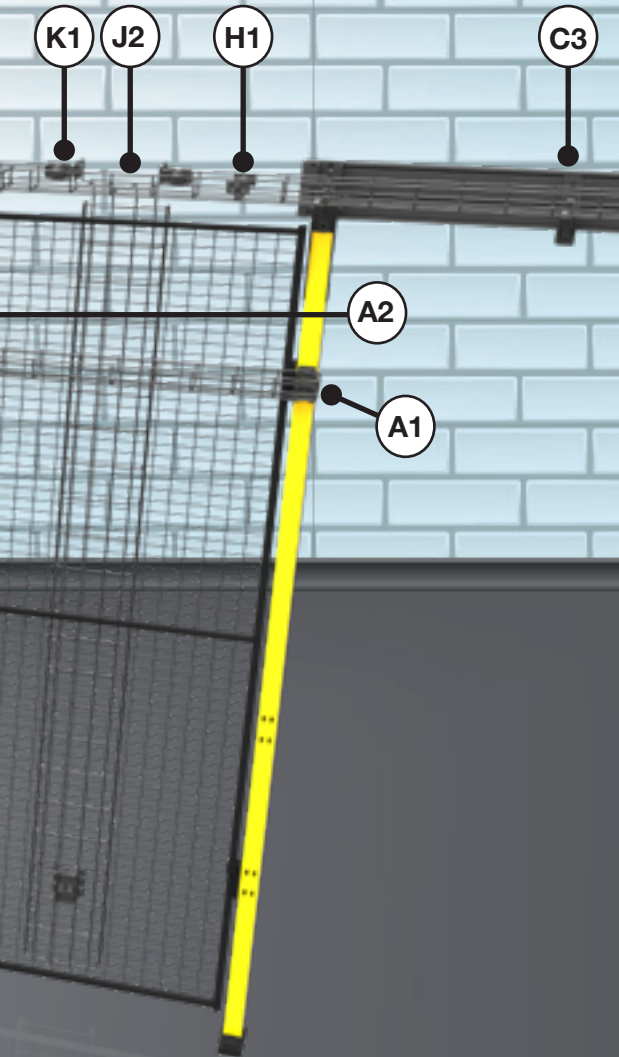

Item Numbers, see next pages »

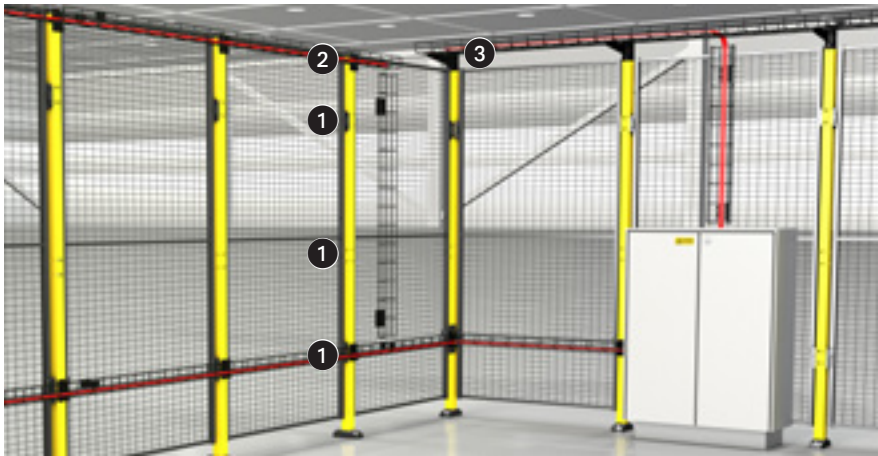

X-Tray

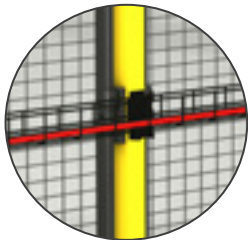

1



2



3



**X-Tray 60x60** L=2300 mm | Wire Ø 4

Item No. | 0701-2300



**X-Tray 120x60** L=2300 mm | Wire Ø 5

Item No. | 0711-2300

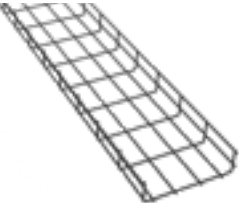

**X-Tray 220x60** L=2300 mm | Wire Ø 5

Item No. | 0721-2300



**X-Tray 320x60** L=2300 mm | Wire Ø 5

Item No. | 0731-2300



**X-Tray 420x60** L=2300 mm | Wire Ø 5/6

Item No. | 0741-2300

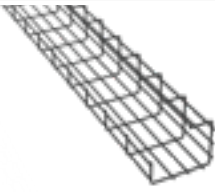

**X-Tray G 120x150** L=2300 mm | Wire Ø 5

Item No. | 1722-2300



**X-Tray Mini 30x22** L=2300 mm | Wire Ø 3

Item No. | 1752-2300

---

**X-Tray Mini 30x22** L=1200 mm | Wire Ø 3

Item No. | 1752-1200



**Post Bracket** A, B

Item No. | 7700-014

For 60-120 cm cable trays. Mounted in the post keyhole (A1 & A4). Together with Corner Post Bracket (7700-065) used in the internal corner (A2). Together with Top Corner Bracket (7700-066) used in the internal corner at the top of the post (A2) or anywhere else on the post.



**Corner Bracket** A

Item No. | 7700-065

Used in the corner together with Post Bracket (7700-014) to put up cable trays (A2) or anywhere else on the post. You can also put a cantilever on it. Self-drilling screws and plugs supplied.



**Post Bracket Top** B, F

Item No. | 7700-015

For 60-120 cm cable trays. Fixed to the top of the post (B1). If you bend up the top part 90° it can be screwed onto the post anywhere (F1). Self-drilling screws and plugs supplied.



**Top Corner Bracket** B

Item No. | 7700-066

Used together with Post Bracket (7700-014) for mounting in a corner at the top of the post (B2). Self-drilling screws and plugs supplied. Bend tabs according to the instructions.



**Cantilever Holder 50x50** C

Item No. | 7700-032

Used for mounting cantilevers on the top of 50x50 posts (C1).



**Cantilever Holder 70x70** C

Item No. | 7700-188

Used to fix cantilevers to the top of 70x70 posts (C2).



**X15 Cantilever** A, C, D

Item No. | 2715-Length

Bracket Holder (C1-2), Bracket Holder Aluminium Rail (C1), Adjustable Post Fitting (D1), Adjustable Corner Post Fitting (D2) and Bracket Holder Post (A3). Can be fixed to Corner Post Fitting (A2). Comes in four lengths 120, 220, 320 and 420.



**Adjustable Post Fitting** D

Item No. | 7700-060

Screwed anywhere on the post to fix cantilevers (D2). Nuts and bolts supplied.



**D**

**Adjustable Corner Post Fitting**

Item No. | 7700-072

Screwed anywhere on the corner post to fix cantilevers (D2). Nuts and bolts supplied.



**C**

**Cantilever Holder, aluminium rail**

Item No. | 7700-037

To fix cantilevers on the aluminium rail over sliding doors (C3). Suitable for cantilever-mounted cable trays. Nuts and bolts supplied.



**A**

**Post Cantilever Holder**

Item No. | 7700-083

Used to mount X15 Cantilevers, mounted in the keyhole on the post (A3).



**E**

**Mesh Panel Mini Bracket**

Item No. | 7700-084

For mounting on mesh panels to bring the cable tray closer to the panel (E1). Used when vertical trays come inside a cantilever mounting.



**E**

**Mesh Panel Bracket**

Item No. | 7700-090

For mounting on mesh panels to bring a cable tray in line with cable trays mounted using a Post Bracket (7700-014) (E2).



**A, B, C, D, F, H, I, K, L**

**X1 Fitting**

Item No. | 2701

The X1 Fitting is used when making a corner (I1) or a reduction (H3). Used together with the X3 Angled Bracket (K1-4) or with other fittings, such as the X14 Pendant (L1) and X15 Cantilever (C1-3, D1-2).



**I, J**

**X2 Fitting**

Item No. | 2702

X2 Fitting is used on a corner with a large radius (I3) or on a drop from a horizontal to a vertical tray (J1).



**I, K, L**

**X3 Angled Fitting**

Item No. | 2703

For a T Junction (K1) or connecting to wall or floor (L2). If the cable tray needs to swing a few degrees, the angle of the X3 Angled Bracket can be adjusted (I2). It is also possible to join vertical and horizontal cable trays (K2-4).



**B, K**

**X4 Fitting**

Item No. | 2704

If you mount trays at the top of posts, you can raise the trays over side-hinged doors using the X4 Fitting together with the X1 Fitting (B3). Used for mounting a vertical cable tray underneath a horizontal (K2).



**H**

**X5 Joining Fitting | 20 pack**

Item No. | 2705

20-pack, nuts and bolts supplied. For joining cable trays. Bracket on the outside and bolt from the inside.(H1)



**X61 Carriage Bolt M8x27 | 40 pack**

Item No. | 2761

---

**X62 Flange Nut M8 | 40 pack**

Item No. | 2762



**X10 Bracket**

Item No. | 2710-1

To mount cable trays on the X11 Pendant or on a wall, a machine or similar. Suitable for 120 cm cable trays and 120-420 cm with the side up.



**X10 Mini Bracket**

Item No. | 2710-2

To mount cable trays on the X14 Pendant, a wall, a machine or similar. Suitable for 60 cm cable trays.



**X11 Pendant** | 240/480 mm

Item No. | 2711-240

Item No. | 2711-480

To mount cable trays with the help of the X10 Bracket or the X15 Cantilever.



**X14 Pendant** | 280 mm

Item No. | 2714-280

Used with the X10 Mini Bracket or to fix cable trays to a floor (L1).



**X68 Equipotential Bonding Screw**

Item No. | 2568

For equipotential bonding/functional bonding.



**X63 Accessories Holder**

Item No. | 2763-1

Used for fitting junction boxes, electrical sockets, or other items on the tray.



**X80 Side Accessories Holder**

Item No. | 2780-1

Used for fitting junction boxes, electrical sockets, or other items on the tray. The fitting is on one edge of the plate and is mounted on two transverse trays (G2).



**X65 Tray Cover** | L=1000 mm

Item No. | 2765-Wide

Length 1000 mm. Width 60, 120, 220, 320 and 420 cm. The cap protects the cables from welding sparks and falling items (G3).



**Vertical Connector**

Item No. | 7700-111

For connecting vertical and horizontal cable trays (K5-7).



**X72 Safety Cap** | 100-pack

Item No. | 2572-Diameter

For 4, 5 and 6 mm wire.  
 Ø 4 ..... X-Tray Width 60  
 Ø 5 ..... X-Tray Width 120, 220, 320  
 Ø 6 ..... X-Tray Width 420



A,B,F



B

**Self-drilling screws**

Item No. | 7100-070

For mounting certain fittings. Surface finish FZB. Included in 7700-015, 7700-065 and 7700-066.

**Knurled Locking Plug**

Item No. | 7500-191

Included to fix Post Bracket Top (7700-015) and the Top Corner Bracket (7700-066) at the top of the post (B1-2). Plastic.



**X75 Bolt Cutter**

Item No. | 2575

Strong bolt cutter with an angled head for easy access.



**X76 13 mm Spanner**

Item No. | 2576

We only use M8 carriage bolts so this is the only spanner you require.



**Cable Bridge** | 1200 mm

Item No. | 279.21.784 – Black

Item No. | 279.28.720 – Yellow

Rubber. Withstands the weight of a truck or lorry. 210x65x1200 mm. 3 cable channels, 2x20 mm and 1x45 mm (G4).



**X77 Wire Cutting Machine**

Item No. | 2577

Unique and fast wire cutting machine that offers completely grade-free cutting of wire up to 6 mm. Made by Klauke with a guarantee of 10,000 cuts. Bag, battery and charger included.

Art. No	Description
0701-2300	X-Tray 60x60 L=2300 mm / Black Zinc
0711-2300	X-Tray 120x60 L=2300 mm / Black Zinc
0721-2300	X-Tray 220x60 L=2300 mm / Black Zinc
0731-2300	X-Tray 320x60 L=2300 mm / Black Zinc
0741-2300	X-Tray 420x60 L=2300 mm / Black Zinc
1722-2300	X-Tray G120x150 L=2300 mm / Black Zinc
1752-2300	X-Tray Mini 30x22 L=2300 mm / Black Zinc
1752-1200	X-Tray Mini 30x22 L=1200 mm / Black Zinc
2568	X68 Equipotential Bonding Screw / Brass
2572-4	X72 Safety Cap 4 mm (100 pcs)
2572-5	X72 Safety Cap 5 mm (100 pcs)
2572-6	X72 Safety Cap 6 mm (100 pcs)
2575	X75 Bolt Cutter
2576	X76 13 mm Spanner
2577	X77 Wire Cutting Machine, Battery powered
2701	X1 Fitting / Black Zinc
2702	X2 Fitting / Black Zinc
2703	X3 Angled Fitting / Black Zinc
2704	X4 Fitting / Black Zinc
2705	X5 Joining Fitting (20 pcs) incl. bolt & nut / Black Zinc
2761	X61 Bolt M8x27 (40 pcs) / Black Zinc
2762	X62 Flange Nut M8 (40 pcs) / Black Zinc
2710-1	X10 Bracket / Black Zinc
2710-2	X10 Mini Bracket / Black Zinc
2711-240	X11 Pendant Premium 240 / Black Zinc
2711-480	X11 Pendant Premium 480 / Black Zinc
2714-280	X14 Pendant 280 / Black Zinc
2715-120	X15 Cantilever 60 -120 / Black Zinc
2715-220	X15 Cantilever 220 / Black Zinc
2715-320	X15 Cantilever 320 / Black Zinc
2715-420	X15 Cantilever 420 / Black Zinc
2763-1	X63 Accessories Holder / Black Zinc
2765-60	X65 X-Tray Cover 60x1000 mm / RAL 9011 Black
2765-120	X65 X-Tray Cover 120x1000 mm / RAL 9011 Black
2765-220	X65 X-Tray Cover 220x1000 mm / RAL 9011 Black
2765-320	X65 X-Tray Cover 320x1000 mm / RAL 9011 Black
2765-420	X65 X-Tray Cover 420x1000 mm / RAL 9011 Black
2780-1	X80 Side Accessories Holder Black Zinc
279.28.720	Cable Bridge, small Yellow
279.21.784	Cable Bridge, small Black
7100-070	Self Drilling Screw, washer head 4.2x19 / Zinc Plated
7500-191	Knurled Locking Plug
7700-014	Post Bracket X-Guard / Black Zinc
7700-015	Post Bracket Top / Black Zinc
7700-065 *	Corner Bracket X-Guard / Black Zinc
7700-066 *	Top Corner Bracket X-Guard / Black Zinc
7700-032	Cantilever Holder 50x50 X-Guard / Black Zinc
7700-037	Cantilever Holder Aluminum Rail X-Guard / Black Zinc
7700-060	Adjustable Post Fitting X-Guard / Black Zinc
7700-072	Adjustable Corner Post Fitting X-Guard / Black Zinc
7700-083	Post Cantilever Holder X-Guard / Black Zinc
7700-084	Mesh Panel Mini Bracket X-Guard / Black Zinc
7700-090	Mesh Panel Bracket X-Guard / Black Zinc
7700-111	Vertical Connector Black Zinc
7700-188	Cantilever Holder 70x70 X-Guard / Black Zinc
9307	X-Tray Demokit X-Guard / Black Zinc

\* Only Corner Bracket, not Post Bracket.

(Post Bracket 7700-014 purchased separately, previously packed together.)

### Order demokit

You can also order a **demokit** of cable trays, brackets and fittings for X-Guard (Item No. 9307).

X-Tray comes in a large range. If there is anything you cannot find, please ask us. Most items can be black galvanized with a few weeks delivery date.

Special colours are available. Even Zinc Plated if your machine is lighter than black.



# SnapperWorks CAD program gives you immediate control of your cables

SnapperWorks pairs X-Tray cable trays with X-Guard machine guards, giving you immediate control of your cables.

## Benefits of X-Tray for X-Guard

- Cost-effective
- Quick fittings designed for machine guards
- Black galvanized for a perfect match with X-Guard (other colours available)
- Several cable routing options
- All bundled and delivered on the same pallet
- Timesaving – quick start-up of machine and production thanks to same pallet shipment (quick and easy installation)

## Benefits of SnapperWorks

- Custom CAD program for X-Guard and X-Tray
- Easy to learn, just click and drag
- Provides a complete drawing and a list of materials in no time at all
- DWG and DXF files can be imported

## Tested and approved

- X-Tray complies with the highest demands on cable routing systems in accordance with IEC 61537
- X-Tray is a complete cable tray system and is available in a larger range in:
  - Zinc Plated FZB
  - Hot Dip Galvanized FZV
  - Stainless 304L
  - Acid-proof 316L

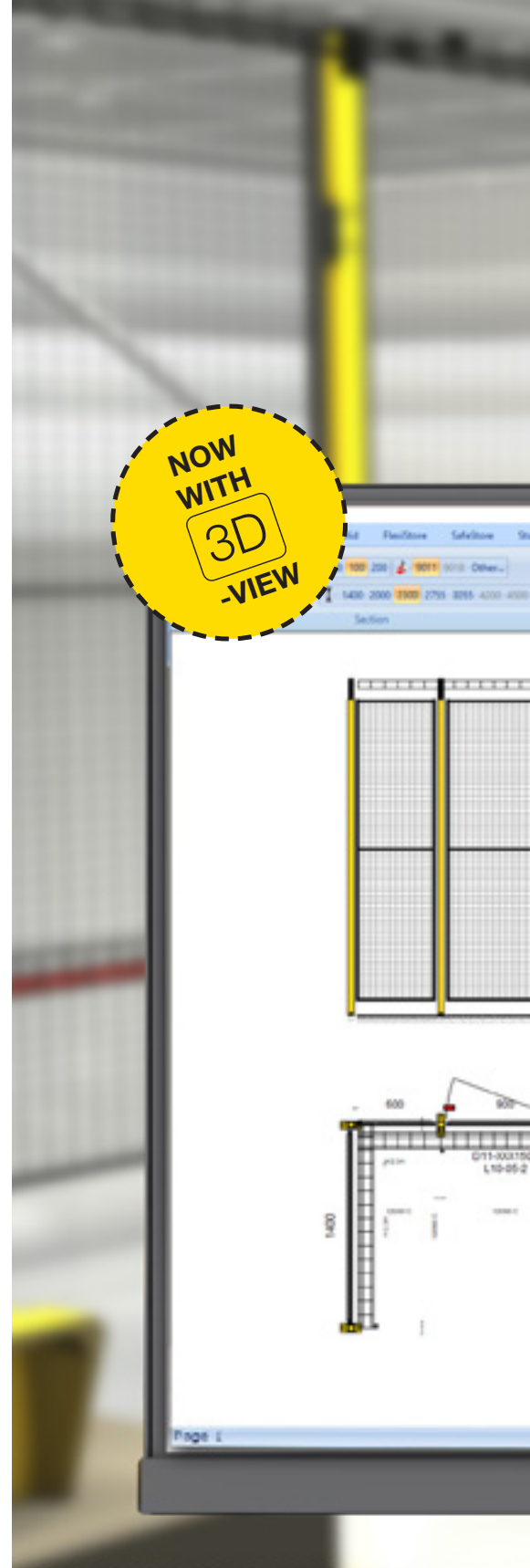





# Which cable tray?

What to consider when choosing cable trays

## Environment

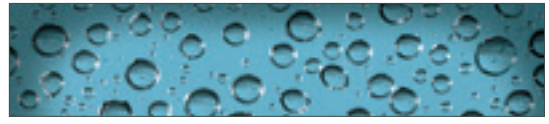

Environmental requirements for surface treatment and/or classification of installation are based on standards, use, surroundings and specified requirements.

## Weight/volume

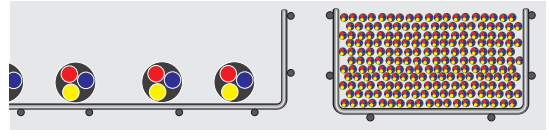

Weight and volume of the cables taking into account future needs.

## Extra weight

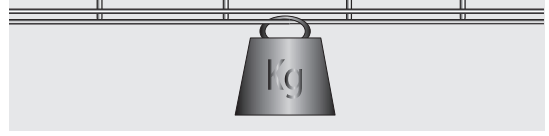

Extra weight from point loads.

## Installation

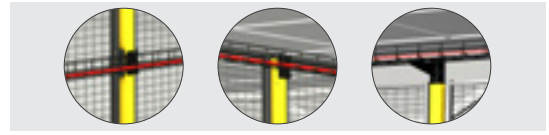

Installations in keyholes, at the top of the post, using brackets or other methods.

## Fixing distance

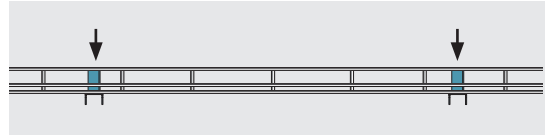

A greater distance between the fixings means less work and lower costs. We recommend a bracket distance of 2.25 metres or, together with X-Guard, adapted to the post distances.

## Equipotential bonding

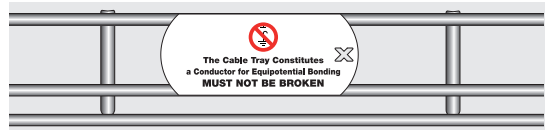

Tested for equipotential bonding.

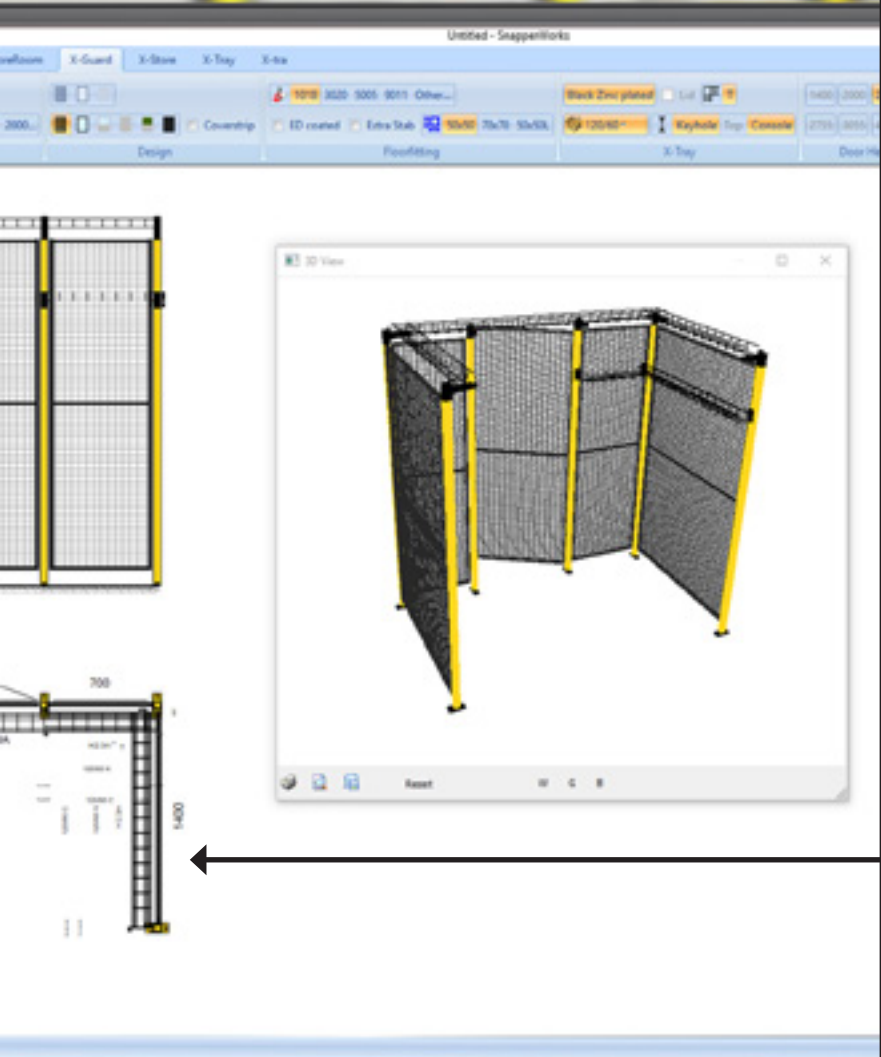

X-Tray

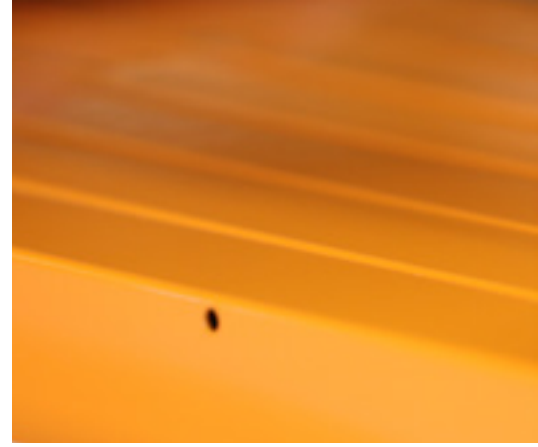

## Powder coating

All products come in standard colours but customised colours are available upon request. Whether you want to use your company's signature colours or match the colour of the machine guard with the rest of your machinery, we will find a solution.

You probably associate us with black and yellow, but we feel that we are partly green as well. We pride ourselves on our environmental efforts. All our products have an eco-friendly powder coating. That is to say free from solvents.

# Powder coating

Axelent's own product range is powder-coated and free from solvents, thus protecting both the indoor and outdoor environments.

Pre-treated with both iron phosphate and alkaline degreaser. Our ALESTA EP powder coatings can be used at operating temperatures from -20 to +60°C. They contain an epoxy-polyester bonding agent and, due to this epoxy content, can only be used for indoor applications.

## Corrosion class

- C2 (indoors)

The film thickness of the coating is 60–150 µm.



# ED paint for tough environments

Sometimes machine guards require an extra durable surface to withstand the toughest environments. An ED paint will make the surface resistant to moisture and able to withstand environments with a lot of solvents.

The paint is an electrolytic dip coating used as the final coating in an anti-corrosion treatment.

Examples of environments where this paint can be used are food processing, mining, unheated rooms and laundries. It is also highly resistant to oil, petrol and other solvents.

## We have considered what lies underneath

Under the ED coating is a zinc phosphate coating for maximum adhesion and to prevent creep corrosion stemming from damage to the finish.

The paint is black and can be used as an undercoat for powder coating, which means that you get a higher

corrosion resistance and can choose any colour you want for the finish.

When measuring the paint it lies between 20-25 µm.

## Corrosion class

- ED paint + Powder Coating – Matching C3 (not outdoors)



## Axellent Safety

Complete safety is not achieved by safe products alone but requires trustworthy products in harness with extensive knowledge and experience. Axellent has a wealth of knowledge and experience of machine safety. We follow developments in the industry very closely and are always at hand to help you keep your machinery up to standard.

On the following pages we have listed the most important things to know about machine safety standards. Would you like us to help you? Contact your nearest sales office.

## Summary of Machine Safety Standards

The current version of the Machinery Directive 2006/42/EC (amended by 2009/127/EC) has been in force since December 29, 2009. It is the basis for all machine safety requirements applicable throughout the EU. A number of published European Standards detail requirements that are applicable to Axelent X-Guard. This is a summary of pertinent quotations from these.

### 1. Fixed guards

Machinery Directive annex 1 chapter 1.4.2.1  
 "Fixed guards must be fixed by systems that can be opened or removed only with tools. Their fixing systems must remain attached to the guards or to the machinery when the guards are removed. Where possible, guards must be incapable of remaining in place without their fixings."

This quite stringent requirement for "no-loss" fasteners has been somewhat softened by the "Guide to application of the Machinery Directive" and a section in the new EN ISO 14120 standard:

"When it is foreseen, e.g. maintenance, that the fixed guard will be removed, the fastenings shall remain attached to the guard or to the machinery. The requirement does not necessarily apply to fixed guards that are only liable to be removed, for example, when the machinery is completely overhauled, is subject to major repairs, or is dismantled for transfer to another site." (EN ISO 14120 5.19).

EN ISO 14120 chapter 5.3.10  
 "Where practicable removable guards shall be unable to remain in place without their fixings."

### VALUES FOR SAFETY DISTANCES

EN ISO 13857 chapter 4.2.2.1.2 table 2

Dimensions in mm

Height of hazard zone <sup>c</sup> <i>a</i>	Height of protective structure <i>a, b</i>									
	1000	1200	1400	1600	1800	2000	2200	2400	2500	2700
	Horizontal safety distance to hazard zone, <i>c</i>									
2700	0	0	0	0	0	0	0	0	0	0
2600	900	800	700	600	600	500	400	300	100	0
2400	1100	1000	900	800	700	600	400	300	100	0
2200	1300	1200	1000	900	800	600	400	300	0	0
2000	1400	1300	1100	900	800	600	400	0	0	0
1800	1500	1400	1100	900	800	600	0	0	0	0
1600	1500	1400	1100	900	800	500	0			
1400	1500	1400	1100	900	800	0	0			
1200	1500	1400	1100	900	700	0	0			
1000	1500	1400	1000	800	0	0	0			
800	1500	1300	900	600	0	0	0			
600	1400	1300	800	0	0	0	0			
400	1400	1200	400	0	0	0	0			
200	1200	900	0	0	0	0	0			
0	1100	500	0	0	0	0	0			

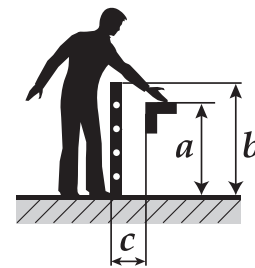

**a** Protective structures less than 1000 mm in height are not included because they do not sufficiently restrict movement of the body.

**b** Protective structures lower than 1400 mm should not be used without additional safety measures.

**c** For hazard zones above 2700 mm, refer to 4.2.1.

## 2. Safety Distances

EN ISO 14120 chapter 5.2.2

"Guards intended for preventing access to hazard zones shall be designed, constructed, and positioned to prevent parts of the body from reaching hazard zones according to ISO 13857. For interlocked movable guards, safety distances according to ISO 13855 shall also be fulfilled."

## 3. Distances to impede free access

EN ISO 13857

"A protective structure can be used to restrict the free movement of the lower limbs under protective structures. When this method has to be used, distances are given in annex A in relation to the height to the protective structure."

## 4. Regular openings for persons of 14 years of age and above

EN ISO 13857 chapter 4.2.4.1

Axelent's X-Guard Premium has an aperture of 19 x 49 mm which requires a safety distance of 120 mm, Axelent's other machine guard systems has an aperture of 29 x 49 mm which requires a safety distance of 200 mm (for further information see EN ISO 13857 chapter 4.2.4.1 table 4).

## 5. Viewing

EN ISO 14120 chapter 5.2.4

"Where viewing of the process is required, guards shall be designed and constructed to offer adequate viewing. This can eliminate the need for defeating them. See also 5.9."

EN ISO 14120 chapter 5.9

"Where viewing of machine operation is required through the guard, materials shall be selected with suitable properties. If perforate material or wire mesh is used this should be of adequate open area and suitable colour to permit viewing. Viewing will be enhanced if the perforate material is darker than the area observed."

## 6. Positive location of removable guards

EN ISO 14120 chapter 5.3.10

"Where practicable removable guards shall be unable to remain in place without their fixings."

## 7. Removal only by tool

EN ISO 14120 chapter 5.3.9

"Demountable parts of guards shall only be removable with the aid of a tool."

In the same section EN ISO 14120 forbids use of quick release fasteners that can be accessed from outside the guarded area. This requirement has been added to prevent side-stepping of the guard. Users could be tempted to remove a fence panel instead of using an interlocked door and thus enter the danger zone while the machine is running.

A "safe system of work" can prevent that. Axelent supplies the X-key as a special tool for quick release (as standard from inside only). The owner of the machine should limit access to this special tool to authorised

Figure A.1 (EN ISO 13857)

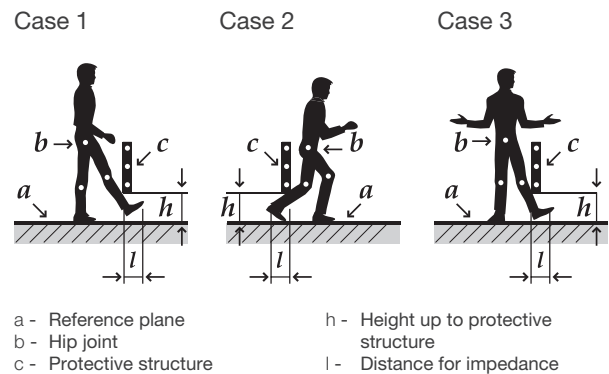

Table A.1 (EN ISO 13857)

Height up to protective structure (h)	Distance (l)		
	Case 1	Case 2	Case 3
$h \leq 200$	$\geq 340$	$\geq 665$	$\geq 290$
$200 < h \leq 400$	$\geq 550$	$\geq 765$	$\geq 615$
$400 < h \leq 600$	$\geq 850$	$\geq 950$	$\geq 800$
$600 < h \leq 800$	$\geq 950$	$\geq 950$	$\geq 900$
$800 < h \leq 1000$	$\geq 1125$	$\geq 1195$	$\geq 1015$

Dimensions in mm

Figure A.1 – Impeding free movement under protective structures.

Table A.1 gives distances for particular cases where access of the lower limbs is impeded when the person remains in a standing position (see figure A.1) without any additional support.

Where there is a risk of slipping or misuse, applying the values given in Table A.1 can be inappropriate.

There should be no interpolation between the values in this table. If the height, h, up to the protective structure lies between two values, then the distance for the higher value of h should be used (for further information see EN ISO 13857 chapter 4.3).

persons to prevent circumvention of the guard.

At the same time fixed guards need to be easily removed and re-installed to ensure they will be re-installed (compare section 6.4.4.1 b).

## 8. Selection of guards

EN ISO 14120 chapter 6.4.4.1

"The following types of guard should be used: "a) Movable guard, if the foreseeable frequency of access is high (e.g. more than once per week) or if removal or replacement of a fixed guard would be difficult. Movable guards shall be associated with an interlock or an interlock with guard locking (see ISO 14119);

b) Fixed guard only, if the foreseeable frequency of access is low (e.g. less than once per week), its replacement is easy and its removal and replacement are carried out under a safe system of work."

**PROTECTION AGAINST REACHING ROUND, DIMENSIONS FOR UPPER LIMBS**

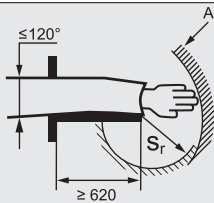
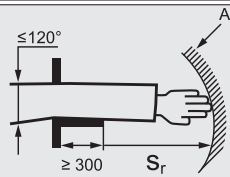
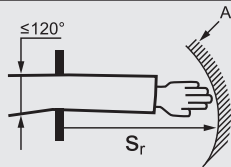

A = Range of arm movement  
 Sr = Radial safety distance  
 a = Diameter of a circular aperture or width of a square aperture or slot

(For further information see EN ISO 13857 Chapter 4.2.3 table 3)

**PROTECTION AGAINST REACHING THROUGH OPENINGS, DIMENSIONS FOR UPPER LIMBS**  
 (EN ISO 13857 Chapter 4.2.4.1 table 4)

The values in the following table apply only to persons who are at least 14 years old. Values in mm.

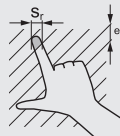
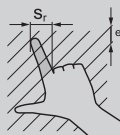
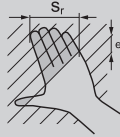
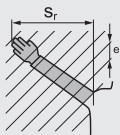
Part of the body	Figure	Opening	Safety distance		
			Slot	Square	Circular
Fingertip		$e \leq 4$	$\geq 2$	$\geq 2$	$\geq 2$
		$4 < e \leq 6$	$\geq 10$	$\geq 5$	$\geq 5$
Finger up to knuckle where finger joins hand		$6 < e \leq 8$	$\geq 20$	$\geq 15$	$\geq 5$
		$8 < e \leq 10$	$\geq 80$	$\geq 25$	$\geq 20$
Hand		$10 < e \leq 12$	$\geq 100$	$\geq 80$	$\geq 80$
		$12 < e \leq 20$	$\geq 120$	$\geq 120$	$\geq 120$
		$20 < e \leq 30$	$\geq 850^{1)}$	$\geq 120$	$\geq 120$
		$30 < e \leq 40$	$\geq 850$	$\geq 200$	$\geq 120$
Arm up to shoulder		$40 < e \leq 120$	$\geq 850$	$\geq 850$	$\geq 850$

The coloured area shows which part of the body is restricted by the size of the opening. For openings > 120 mm the safety distances for reaching over must be used and additional safety measures taken.

<sup>1)</sup> If the length of a slot is  $\leq 65$  mm, the thumb acts as a stop. The safety distance can then be reduced to 200 mm.

\* The graphics are owned by Axelent

**9. Geometrical factors**

EN ISO 12100 chapter 6.2.2.1

"The design of the machine shall be such that, from the main control position, the operator is able to ensure that there are no exposed persons in the danger zones."

**10. Measures for the escape and rescue of trapped persons**

EN ISO 12100 chapter 6.3.5.3

"Measures for the escape and rescue of trapped persons may consist, e.g. of:

- escape routes and shelters in installations generating operator-trapping hazards;
- arrangements for moving some elements by hand, after an emergency stop;
- arrangements for reversing the movement of some elements;
- anchorage points for descender devices;
- means of communication to enable trapped operators to call for help."

*As this is a sample from the applicable standards, we recommend that you read the standard relevant to each application. The basis for any decision on guards and other protective measures should always be a careful risk assessment of the entire machine and process. This document is subject to changes in applicable directives and standards.*

The following text and diagrams have been reproduced with the express permission of SIS Förlag AB Stockholm, Sweden, +46 8 555 523 10, HYPERLINK "<http://www.sis.se>" [www.sis.se](http://www.sis.se) who also sells the standards referred to in the text.

