



# Axelent **X-Guard**<sup>®</sup>

Welcome to a safe world

Version  
2.0  
English  
Benelux









# Made in Sweden. Works global.

The Axelent Group has grown into an international group of companies with a total workforce of over 300 people. Our products are sold in 60 countries and our vision is to keep on expanding.



Axelent is a Swedish company with extensive experience within the manufacture of mesh wall systems in the form of protection and partitioning systems for industry, warehouses and construction. Speed, safety, service and smart solutions are watchwords that characterise our entire organisation and business. We are market leaders within several sectors and our products are represented all over the world.

## **The world has become yellow and black**

Yellow posts and black panels have always been Axelent's hallmark right from the start, the colors inspired by our logo. For a long time we were alone in these colors and it was easy to recognize Axelent in the market. Today things are different. You can no longer be sure that the yellow and black machine guards you see are made by Axelent. Something, however, you can be sure of is that our high standards of security, speed and smart solutions have made us one of the market leaders in machine safety. We are represented in 60 countries worldwide, and while our colors have now become universal, Axelent is still the original.

## **Effective production**

Our head office is in Hillerstorp, Sweden. All product development, production, warehousing and packaging also takes place here. Much of our production is automated in order to cope with high volumes and fast delivery times. As all our standard products are in stock we can deliver your order within 5-7 working days.

## **Quotation and drawing straight away**

Our own SnapperWorks drawing application enables us to quickly provide you with a quotation including a drawing and material specification.

## **A safe choice**

Axelent has extensive, in-depth knowledge when it comes to safety for industry, warehouses and construction work. Please consult us in order to get a safe and secure environment as possible using our products.



# Axelent AB – Our speed and service is based on **Rational production and an effective organisation**



**Axelent AB Hillerstorp.** Our 31,000 sq. m. premises houses product development, production, packaging, warehousing and sales.

**Raw material storage.** Our raw material storage houses large volumes of wire and rectangular hollow sections (RHS), the basis of all our products.

**Production.** Axelent boasts the most modern cutting centre in Europe. Here, the hollow section is cut, drilled, tapped and washed before going further on in our X-line™, thus avoiding time- and space-consuming intermediate storage. In our X-line™, complete mesh panels are produced in a very rational process. X-Tray cable trays are manufactured in Sweden using a fully automated robot line.







**X-PACK™**



**Capacity.** At Axelent we have the capacity to produce 80,000 mesh panels a month.

**Coating.** Coating is done using powder, which means no solvents.

**X-Pack™.** Our own packaging system enables us to place all our mesh panels on specially designed pallets for rapid and smooth assembly. X-Tray for X-Guard is co-packed with X-Guard. All deliveries are plastic wrapped together with the assembly instructions and other delivery documentation.

**Readymade stock.** All our standard products are in stock, guaranteeing fast delivery.



## X-Tray® for X-Guard®

X-Tray cable trays integrate easily with Axelent's X-Guard machine guards. Together they become the ultimate choice.

X-Tray cable tray is strong, smooth and yet easy to mount. You create elegant solutions without the need for a variety of special tools. Just like with X-Guard, only a few brackets and tools are required. The X-Tray and X-Guard combination gives you maximum flexibility based on minimal material – simple and above all smart. Thanks to the almost endless possibilities, despite few components, you do not need to add time and money to any additional orders to complete the project.

X-Tray cable trays are co-packed with X-Guard mesh walls on the same pallet. Fast, smooth and economical!



# X-Guard® – machine safety of the

X-Guard is the market's most complete machine guard with custom cable routing. X-Guard is the number one machine guard that complies with the Machinery Directive's demands on permanent guards from 29 December, 2009.

With its wide range of standard components and accessories, X-Guard is guaranteed to cover all possible machine guard needs. We can also offer X-Guard Contour, which is the market's first machine guard with round corners.

### Safe

Axelent's machine guards are designed to fulfil all the demands put on a functional machine guard.

### Functional and smart

In addition to safety, it is vital that our products work as

smoothly as possible. Our machine guards have many smart solutions to facilitate the flows in and around the machines that require this type of protection.

### Simple

Our machine guards are built around a standard design with regard to panels, posts, accessories and colour. This makes it easier for you to complement existing guards if required.

### Complete

X-Guard machine guards are available in mesh panel sections or sheet plate and plastic sections (see X-Guard Technical (p. 4-7)). Axelent's large selection of doors, locks and accessories offer a complete machine guard solution tailored to your needs.

### Cost-effective

Smooth and easy handling, together with speedy delivery and assembly, always gives you a good overall economy when choosing Axelent's machine guards.





## X-Guard® Contour

In 2012 Axelent launched a unique machine guard, X-Guard Contour, and it has gone on to become a popular choice among our more traditional guards. The rounded panels are part of our X-Guard range and can be combined with other X-Guard components. X-Guard Contour is not only the perfect solution for confined spaces but also offers a unique sleek finish.

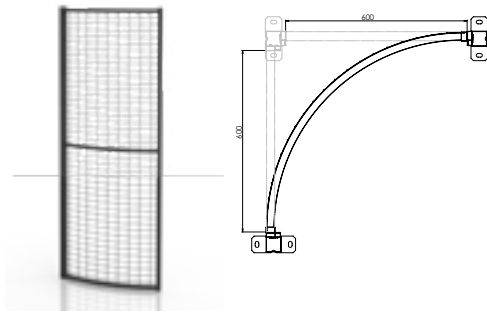

### Axelent X-Guard® Contour

The panels come in three different heights, 1300, 1900 and 2200 mm and in 90° angle.

Standard panels come in colour RAL 9011 but can be customized to specific requirements.

*For more information see X-Guard Technical.*

## future

### A machine guard that grows

X-Guard was launched in 2008, since then new dimensions in panels, posts and accessories have been added. We listen to our customers to enable us to develop the range as new needs arise.

### Space-saving

It may seem like only a small improvement, but nobody has previously dared to veer from the traditional machine guard design with 90° right angles.

By opening ourselves to new shapes we allow the machine guards to be an attractive yet integrated part of the whole solution. With X-Guard Contours more friendly design, you don't have to deal with square corners that take up unnecessary space, and you'll get a machine guard that smoothly fits in the production environment.

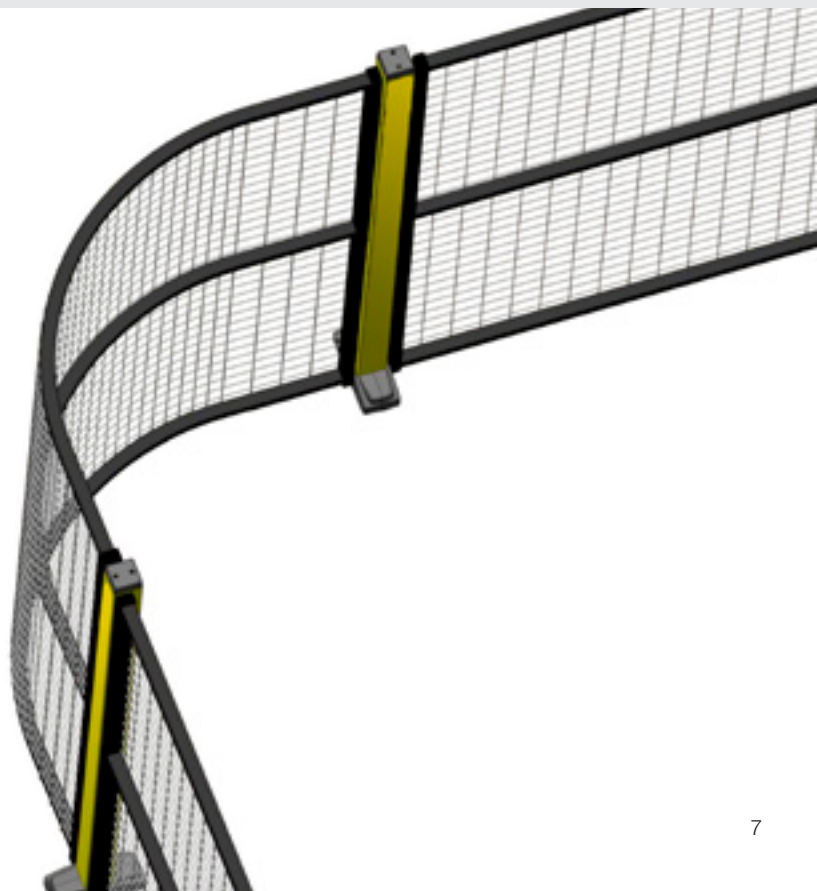

# X-Guard®

Machine guarding without limitations





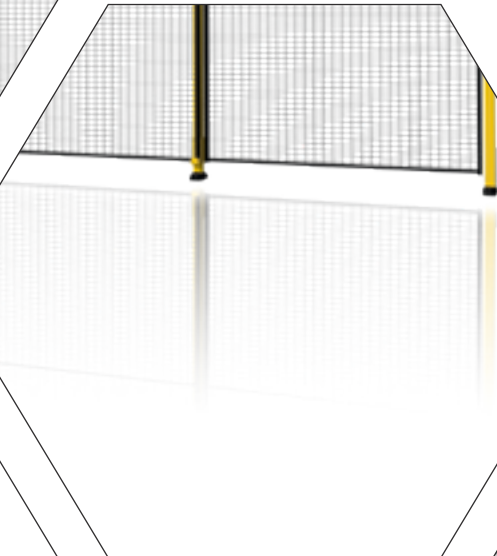
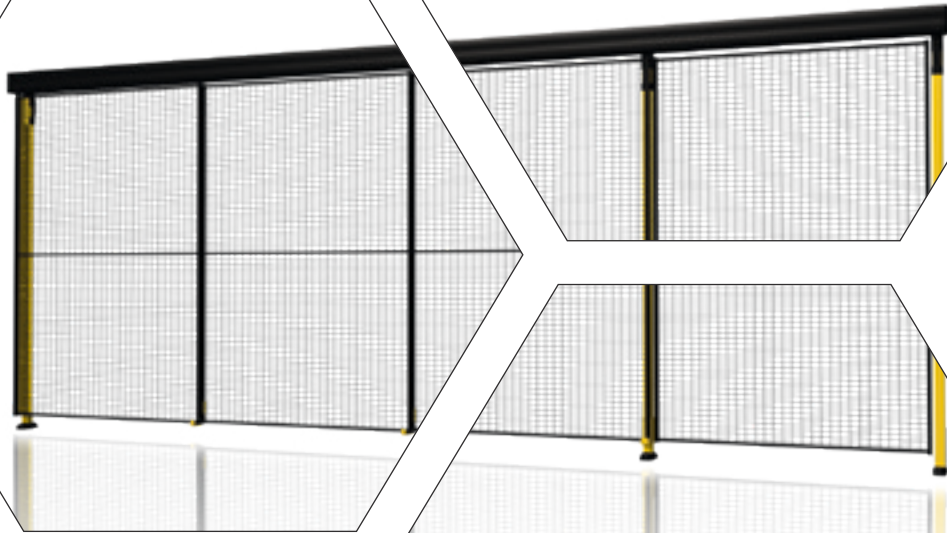
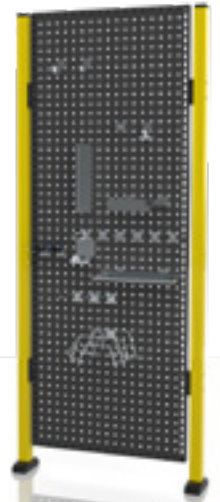
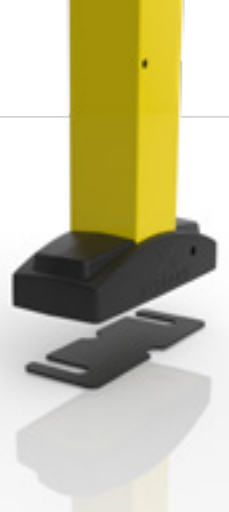
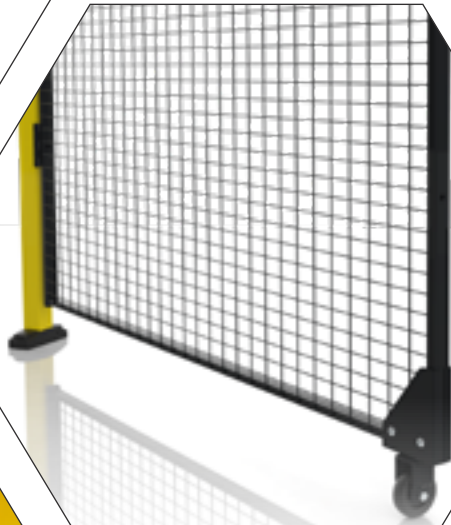



## **Your safety is our business concept No matter where in the world you are**

At Axelent we know what production standstill can cost and we are aware of the consequences of poor safety in production. We also know that the regulations surrounding machine safety can be complicated to find your way around.

We therefore offer all our customers a safety package. A holistic approach with the tested and approved machine guarding forming the core, combined with our know-how and service to provide you with an effective and rapidly delivered machine safety solution. At Axelent we seek to become your safety partner, no matter where in the world you are.





## X-Guard® has as many advantages as smart details

- ✓ X-Guard is quick to assemble thanks to punched holes and pre-mounted fittings.
- ✓ X-Guard Lite is a simpler version of X-Guard and an alternative when you need a more cost-effective solution.
- ✓ Thanks to X-Guard's smart door solutions you do not need to pre-determine whether you need a left or right-hinged door (not X-Lock and X-It).
- ✓ X-Guard Contour is the alternative with rounded corners. Everything for a sleek and functional design!
- ✓ Axelent X-Tray are customized cable trays with smart fasteners which can be integrated with X-Guard machine guard.
- ✓ X-Guard sections are available in 13 widths and 4 heights.
- ✓ X-Guard posts have a smart design with factory-drilled holes on three of the four sides, making it versatile with no special post required in corners.



## X-Key. The key to success

### **A unique detail**

A unique key for quick panel release. Forget about tools. All you need is X-Key.

### **Quick release and replacement**

X-Guard panels can only be removed with the special X-Key. The X-Key offers quick release and replacement. As standard this is possible only from inside the hazard zone. This is also the setup recommended by Axelent,

because it ensures that the respective machinery is stopped upon opening a movable guard.

Fixed guards can then only be removed under safe conditions. However, if specifically required for particular maintenance jobs or because of space restrictions removal of panels is also possible from outside the guarded area. Accessory parts are required to install X-Guard for this type of access.



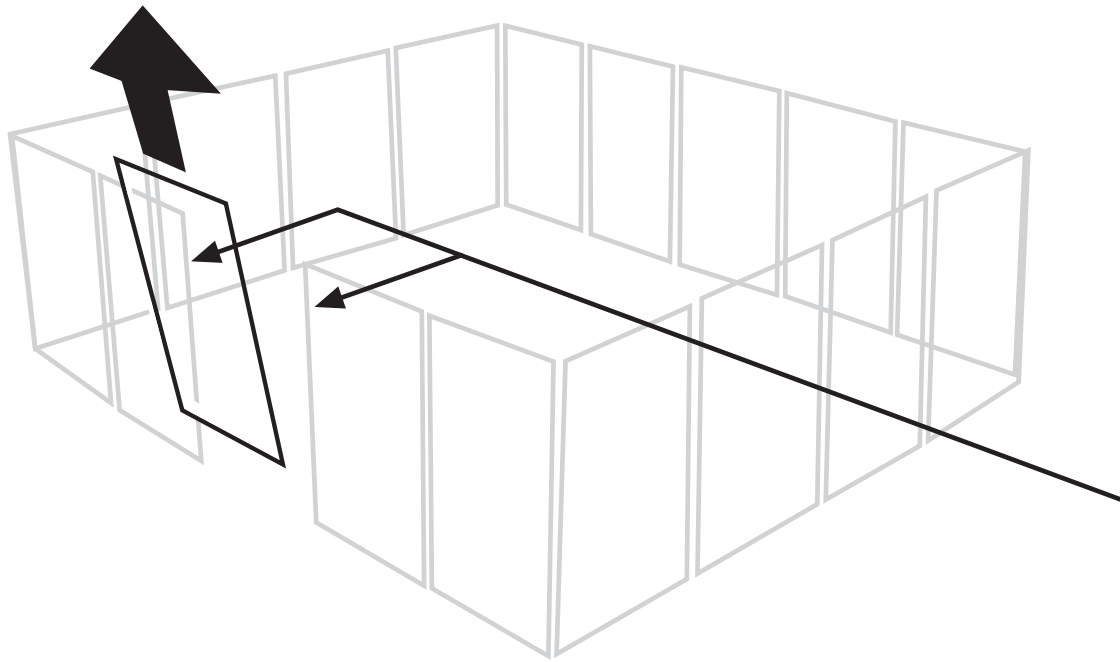

# X-Guard<sup>®</sup> – a flexible system with extremely smart solutions

Axellent offers endless combinations and solutions in X-Guard – the most flexible system in machine guarding.

Doors and panels are designed to ensure you can switch whenever necessary. You can change hinge and lock

handling with a simple operation.\* This means you can quickly change the machine guard as and when the need arises.

*\* Does not apply to X-It or X-Lock.*

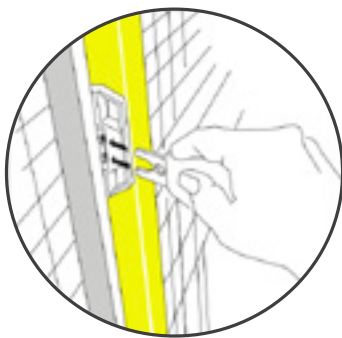

Use the X-Key, place it into the upper fitting ...



... push it to the side ...

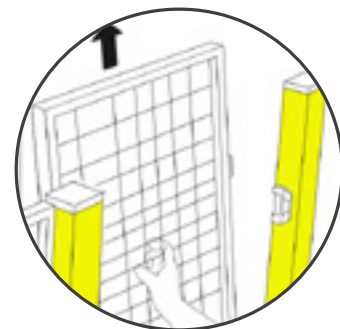

... and the panel will come loose. Done!

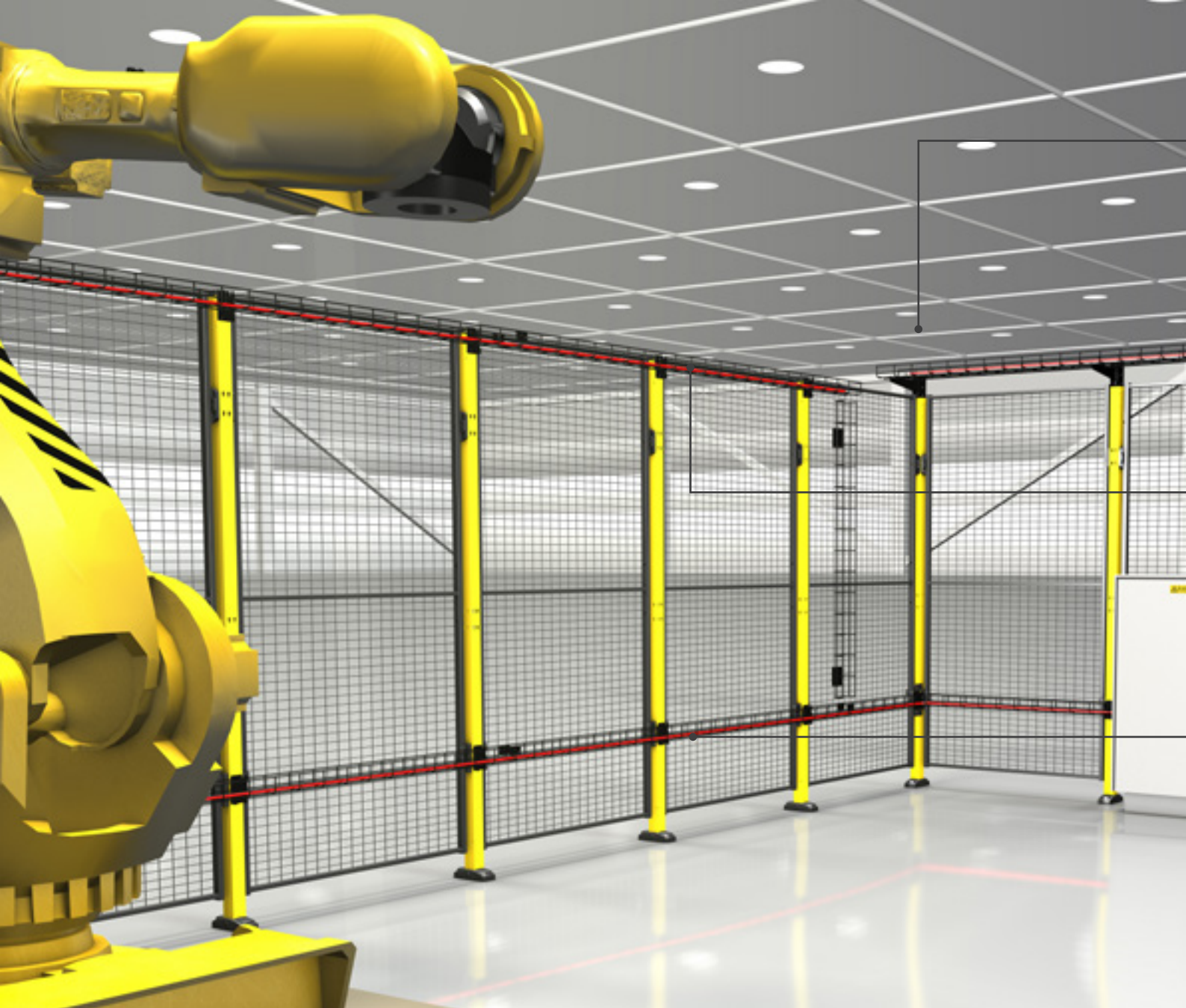

## X-TRAY®

Our product range also includes our X-Tray brand. X-Tray is a complete range for all cable routing. X-Tray for X-Guard uses smart and flexible cable trays that are customizable and compatible with the X-Guards system. All X-Guard cable trays are black-zinc plated to give a stylish and integrated look. The product is durable, quick, and easy to install. Just like X-Guard, X-tray also only needs a few brackets and tools to install. With X-Tray you can create elegant solutions without the need for welding. It's easy to integrate the cable trays and create solutions as well as make any changes to the design on the go



Axellent's drawing program SnapperWorks pairs X-Tray cable trays together with X-Guard integrating them right from the start. This means your cables are already sorted quickly and simply. Both X-Tray and X-Guard even come co-packed on the same pallet. Smooth



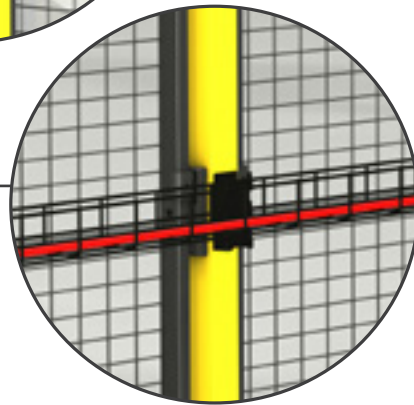
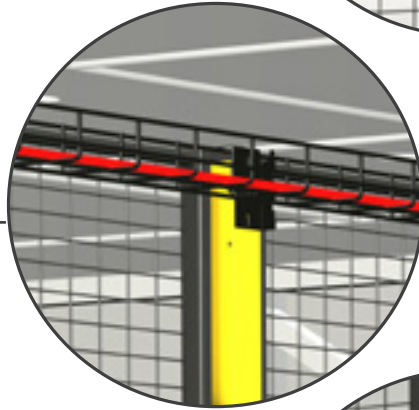
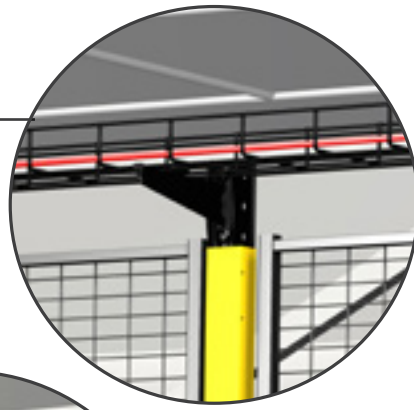

## No machine guard is complete without X-Tray<sup>®</sup>

X-Tray cable trays integrate easily with Axelent's X-Guard machine guards. Together they are the optimum choice.

Our cable trays are strong, flexible and easy to fit. You can create elegant solutions without the need for special tools. Just like X-Guard, only a few brackets and tools are required. By combining X-Tray and X-Guard you get maximum flexibility from a minimum amount of material. Simple and smart. Thanks to the almost endless possibilities, despite few components, you do not need to spend time and money on additional orders to complete your project.

### **Easy to combine**

Axelent's X-Tray is the perfect solution for cable trays together with X-Guard machine guard.

### **No special tools**

The combination is easy to assemble without the need for any special tools.

### **One supplier**

Turnkey solutions from one supplier make project implementation quick and easy.

*More technical information about X-Tray can be found at p. 32-41 in X-Guard Technical.*

# Safety, service and knowledge

Complete safety is not achieved by safe products alone but requires trustworthy products in harness with extensive knowledge and experience. Axelent has a wealth of knowledge and experience of machine safety. We follow developments in the industry very closely and are always at hand to help you keep your machinery up to standard.

## Safety Book

---

Axelent's focus is, and has always been customer's safety. We know that the greatest challenge faced by our customers is the lack of information and solutions for creating a safe workplace in machine and automation areas. Therefore we decided to create a unique guide book to give you the answers you need. We have combined the hard facts with our know-how. The author, Matthias Schulz, is a machine safety expert. He is an independent machine safety consultant who is collaborating in a joint venture with Axelent. The result is a simple and easy to understand guide – a Safety Book.



Do you feel lost in the jungle of machine safety standards? Contact your nearest sales office and be one of the chosen few to get this unique book. It cannot be ordered or downloaded.











## Axelent, a turnkey concept

Axelent gives you more than just mesh. Our concept is built around a turnkey solution of more than one product. We do all we can to give our customers the best possible service.

We always strive to live up to your expectations with regard to products and services. Our motto is Axelent Quality – service, safety, speed, spirit and know-how.

### Customer support

---

At Axelent we do all we can to give our customers the best possible service. Don't hesitate to contact us if you have any queries regarding our products, assembly, etc. You are also welcome to call us if you seek general advice about machine guards or machine safety.

### We guarantee, deliver and assemble!

---

- ✓ We give you a quote including drawings within four hours.
- ✓ Inquiries received in the evening or at night are dealt with by 11 am the following day.
- ✓ We can provide a professional and experienced installation service for complete peace of mind.



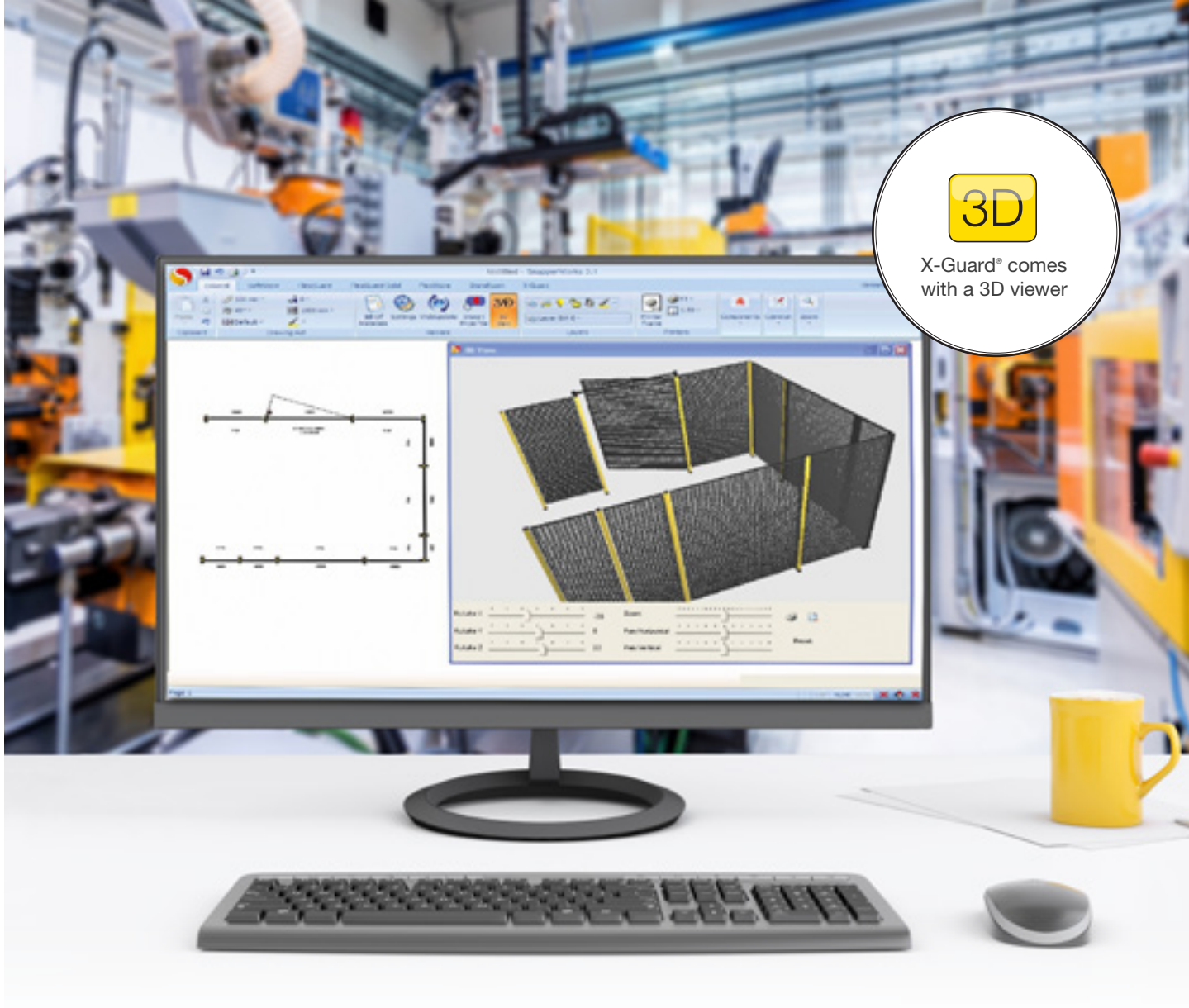

**3D**  
X-Guard® comes with a 3D viewer

# SnapperWorks, simple and brilliant

Axelent's in-house developed, user-friendly drawing application, SnapperWorks, enables our customers to get a quick layout drawing of for example X-Guard. At the same time you draw the machine guard you can also choose

to get a layout drawing including cable trays (X-Tray for X-Guard).

Everything is prepared, all you have to do is click and drag to get a complete drawing with all the parts you need.

## The benefits of SnapperWorks are many ...

Read more about SnapperWorks: [www.snapperworks.com](http://www.snapperworks.com)

- It is tailored to Axelent's modules and contains all our mesh panel, machine safety systems and X-Tray for X-Guard.
- It is easy to learn.
- The program enables you to import DWG and DXF files and draw, for instance, panels straight onto the drawing.
- From specified lengths you can let the program configure the most economical panel layout.
- It quickly provides you with a complete drawing including material specifications.



Click and drag! It is that simple and quick to get an overview of what you need and what your mesh panel system will look like. The drawing can then be used as an order basis.

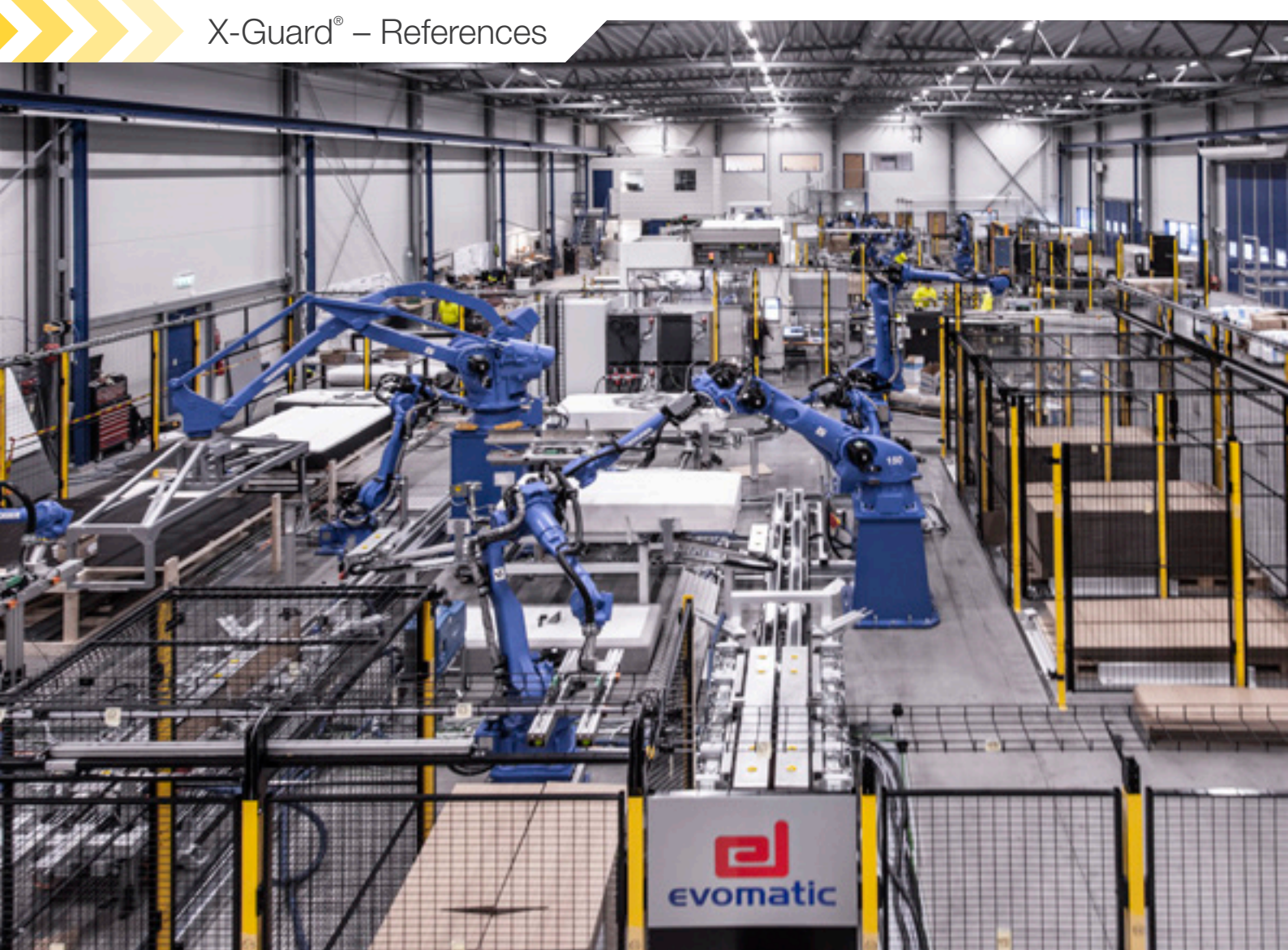

## Projects from Sweden

Axelent has become a turnkey safety supplier. We know that staff safety has the highest priority, but also that the industry has to function efficiently. Therefore, we always look at the whole picture and can carry out everything from risk analysis to the installing and approval of safety equipment for your machine line and storage. We also offer follow-up and software to enable you to maintain the best possible safety levels in your company.

*Pictures from Evomatic AB, Karlshamn, Sweden*



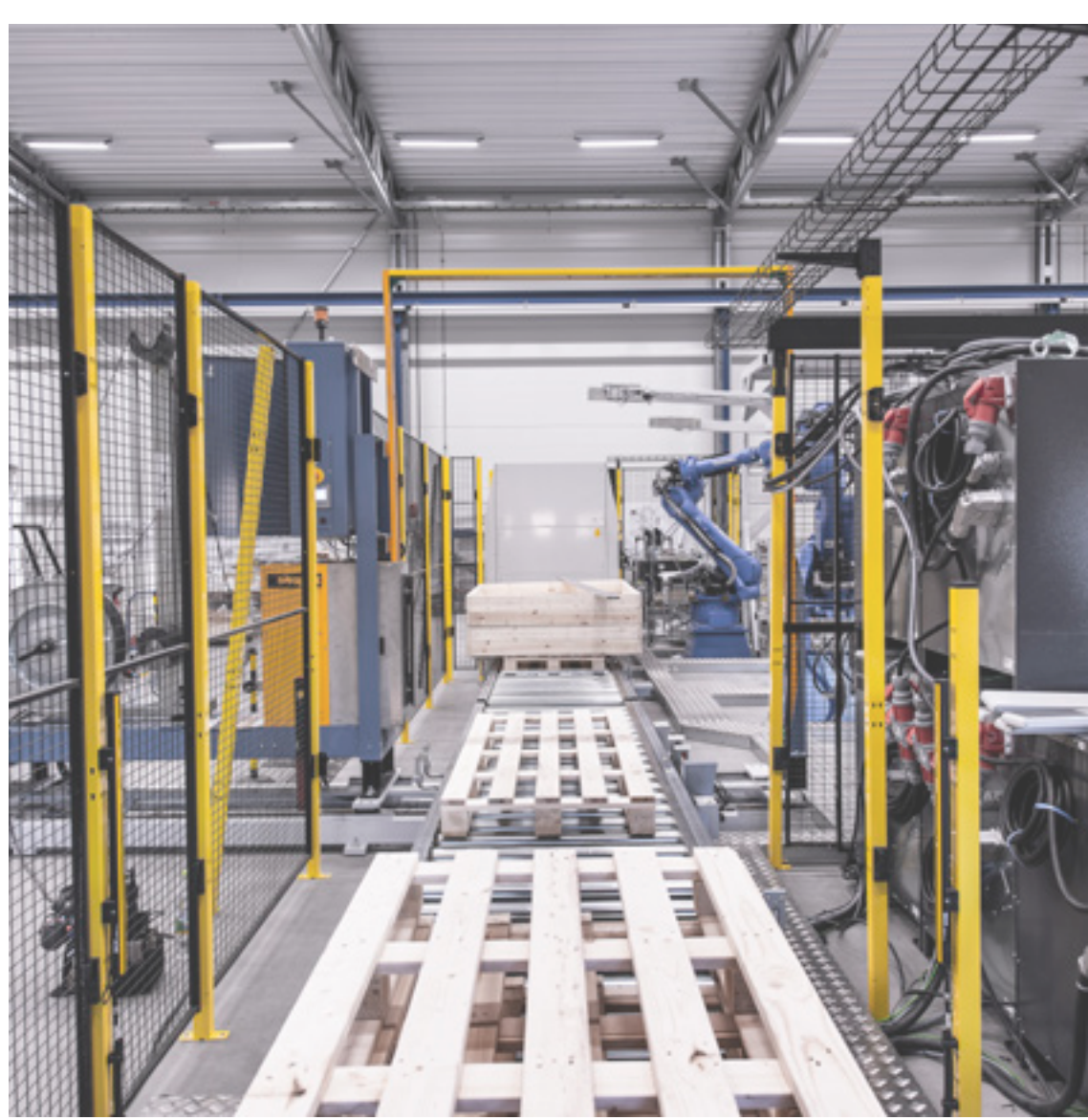





## NLR, Netherlands Aerospace Centre

NLR develops innovative and turnkey solutions for the complex challenges faced by the aerospace industry. The operation covers the whole spectrum of research, development, testing and evaluation, from validation and verification to eligibility, simulation and follow-up. NLR bridges the gap between research and practical applications, and works for both private and public sectors in the Netherlands and abroad.





### Example of work carried out in the NLR laboratory

Stefan Grudelbach, Sales Manager, Axelent Netherlands B.V.: On some aircraft models, the main landing gear has a brace made of carbon fibre. The fibres are woven onto this brace using the braiding machine you see behind X-Guard's plastic walls. Only prototype manufacturing takes place of carbon fibre braces. The braiding machine is used only for product development. NLR builds and tests aerospace products together with manufacturers like Fokker, Boeing, Airbus and Lockheed Martin."

### Axelent's products in the NLR laboratory

"The NLR laboratory operates according to the cleanroom air flow principle, with low levels of dust, airborne particles and chemicals. This is why we chose X-Guard plastic walls to attract as little dust as possible. The walls also come into their own when the customer wants to check their product in the laboratory because they give a free view – and a clean and exclusive impression as an added bonus. The machine guard is 2300 mm in height, but the customer chose a lower height (1400 mm) in front of the machine to give a better view of the project and braiding process. The posts are 50x50 in standard yellow (RAL 1018). In front of the machine we also put a door equipped with a hitch lock."

### X-Guard ensures that the machine cells can work uninterrupted

"The braiding machine will be operated by a single person well-versed in the risks involved with the machine. This is one of the reasons the customer chose not to equip the front doors with a breaker. As I mentioned earlier, the carbon fibre products will be managed by hand in the first machine cell (the braiding machine). The second cell has several different fully automated processes. First a robot is picking up plies cut out of a carbon fibre weave by a cutting machine and stacking them together. Secondly an infrared heater is used to vacuum form these carbon fibre preforms to the desired shape. This seemingly simple process gives the carbon fibre great durability."

### Complete machine safety in three days

"The NLR project was divided into two stages. Stage one was to secure the robot cell with the help of X-Guard. When everything was commissioned and fully functioning, the braiding machine was secured. The whole project took a total of three days to assemble."



## Rounded but no cut corners at Formteknik in Sweden

Toolmaking company Formteknik operates within three main customer segments: Thin Wall Packaging, Caps & Closures and Medical Devices. The company has branches in Anderstorp, Sweden and Roskilde, Denmark. When Formteknik were in the market for machine guards to protect their new robot cell they put design and functionality top of the list and chose Axelent X-Guard Contour without hesitation.

### Jan Aronsson, Managing Director:

"One look was all it took for us to realise that Axelent's X-Guard Contour was the perfect guard for our new robot cell. The rounded corners are not only stylish but functional as well. They save us space and make it easier to move around the guard. As well as the functional benefits, the guard looks stylish and well-designed, which we like a lot as it suits our plant perfectly. We always want the best, for ourselves as well as for our customers."



X-Guard  
Contour













## Projects from Axelent Australia PTY LTD, Australia

- ① 800 posts and panels (X-Guard) were used together with a variety of door solutions to deliver a customised solution. A project that took three months from the initial order to completion.
- ② Same project as above.
- ③ Customised solutions with extra high panels to reach the desired height of 5.25 metres. From the first order to the final installation, the project took 12 months to complete.







# The world of Axelent

It is vital that Axelent is run in an ethically, socially and environmentally correct manner regardless of where our location might be in the world. Contributing to a sustainable society is a key part of our operations and is vital to our future success.

We take responsibility in everything we do – from the business relationship, to human rights and the environment.

## Environment and sustainable work

Environmental, health and safety issues are an integral part of Axelent's operations. Through management by objectives we will achieve constant improvements in this regard.

We adopt an approach that leads to long-term sustainable development through continuous improvements that contribute to reducing all conceivable environmental impact by:

- Providing resource and cost-effective solutions
- Complying with laws, ordinances and customer requirements relating to environmental responsibility
- Striving for high efficiency levels in our use of energy and natural resources
- Favouring systems for the recycling and reuse of material
- Preventing and limiting pollutants

To find out more about how we work for a sustainable society from an ethical, social and environmental perspective go to [www.axelent.com](http://www.axelent.com) and download our Code of Conduct.

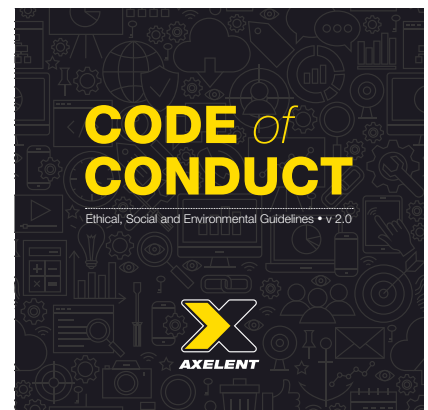

## **Axelent AB**

---

Axelent AB, a leading manufacturer and global supplier of mesh panel systems for machine guarding and partitioning within industry, warehousing and lost prevention. The head office is located in Hillerstorp, Sweden, along with research and development, production, storage and packaging. Axelent has sales offices in 60 countries and subsidiaries in more than 10 countries.

**[www.axelent.com](http://www.axelent.com)**

## **Axelent Engineering AB**

---

Axelent Engineering AB provides services and products within automation predominantly to producing industry in Scandinavia. The core business is custom hardware and robotic solutions with an emphasis on profitable flow for the entire lifecycle. By partnering with Dassault Systèmes, a world leader in 3D and PLM (Product Lifecycle Management) solutions we can also offer PLM services and products such as CATIA, 3DVIA, DELMIA and ENOVIA. This combination makes Axelent Engineering an even more complete partner for the industry in terms of innovative and profitable flows.

**[www.axelentengineering.se](http://www.axelentengineering.se)**





## Axelent Software AB

---

Axelent Software develops and markets user licences for their in-house software applications SnapperWorks and SafetyWorks. The programs are based on distributed platforms and standards that ensure a long length of life, continuous development and easy connectivity to other systems. Axelent Software's products are based on simplicity and ease of use and is in its original version developed for Axelent's products, but through various customizations applicable in most industries with standardized products.

[www.axelentsoftware.com](http://www.axelentsoftware.com)

## Axelent Safe-X AB

---

Safe-X offers a broad and varied product portfolio with everything you need for outdoor environment, industry, warehouse and workplace. As well as Axelent's renowned storage partitions, there are cycle racks, waste bins, speed bumps, mesh shelves, collision bollards and much more.

[www.axelentsafex.se](http://www.axelentsafex.se)

# Axelent Group



*At Axelent, it is important to us that your overall experience is a positive one, from your first contact with our team, through to installation and follow up service. Your feedback is important to us, so we can maintain our reputation as a quality supplier.*

*Our speed, company culture and knowledge allows us to serve you quickly and provide the very best possible safety solutions. This is the foundation of our 'simple' but unique business model, a model which has made Axelent one of the leading brands in the industry.*



AXELENT BELGIUM NV · GESTELHOFLEI 14C · 2820 BONHEIDEN · BELGIË  
TEL : +32 15 50 99 80 · FAX : +32 15 50 99 81 · INFO@AXELENT.BE  
WWW.AXELENT.BE

AXELENT NETHERLANDS BV · BIJSTER 15 · 4817 HZ, BREDA · NEDERLAND  
TEL : +31 76 562 05 28 · E-MAIL : INFO@AXELENT.NL · WWW.AXELENT.NL

